

Est. 1923

IB

IDEAL

PAVERS | WALLS | ELEMENTS

100
YEARS
1923-2023



As we celebrate our 100th Anniversary, we wish to thank the many customers who have chosen Ideal as their supplier of choice through the years. During our long history, we have seen products, styles, colors, and finishes evolve, including our new logo that honors the strong tradition of quality and service that has guided our company for a century. What has stayed the same is our commitment to excellence. Our knowledge and expertise in producing quality concrete products go into every product we develop, manufacture, and offer.

We welcome the opportunity to make new customers and invite you to browse our 2023 catalog showcasing our most popular products. As you browse the pages, we hope the project photos provide ideas and inspiration for your home. It features the many styles, shapes, colors, and finishes homeowners and professional contractors alike have selected as their product of choice to expand their personal style to the outdoors.

From our family to yours, we are pleased to offer products that welcome you to Come Home and Be Home With Style.

The Burgoyne Family



TABLE OF CONTENTS

4-7	OUR HISTORY	66-71	COPING
		68-69	Ancestral Coping
		68-69	Universal Coping
8-19	OUTDOOR LIVING INSPIRATION	70-71	CastStone RockFace Coping
		70-71	Bullnose Coping
20-31	COLOR 4D PAVERS	72-81	ELEMENTS
22-25	Andover Collection	76-77	Rockport Steps
26-27	Andover 5511 Smooth	76-77	Rockport Pathway Stones
28-29	Portsmouth Cobble	78-79	Carlisle Pillar Cap
30-31	Windsor Slab	78-79	Chelmsford Step
		80	ScapeStone & ScapeStone XL Fire Pit
32-41	TRADITIONAL PAVERS	80	Fire Pit CastStone Coping
36-37	Yankee Cobble	81	Olde Boston Fire Pit
38-39	Boston Colonial	81	Roman Pisa Fire Pit
40-41	BrookStone		
42-47	TUMBLED PAVERS	82-85	FIREPLACES & OVENS
44-45	MillStone	84-85	King of Hearths
46-47	Georgetown Colonial		
48-53	PERMEABLE PAVERS	86-93	NATURAL STONE
50-51	Aqua-Bric & Aqua-Bric 8	88-89	Natural Stone Veneer
52-53	Turfstone	90-91	Granite & Bluestone
		92-93	Bulk & Palletized Stone
54-65	WALLS	94-95	MEETING YOUR EXPECTATIONS
58-59	Ancestral WallStone	96-97	PHOTO LEGEND
60-61	Fat Face	98	PAVER INSTALLATION
62-63	Olde Boston Wall	99	RETAINING WALL INSTALLATION
64-65	Roman Pisa		



OUR HISTORY 100 YEARS 1923-2023



100 years ago, our grandfather Leo Burgoyne had a vision for his family and newly formed company. Named after the machine used to produce the product he sold, Ideal manufactured concrete blocks for homes throughout the Boston area.

With a robust work ethic and unwavering determination Leo labored for his dreams... seven days a week, year after year... during the Great Depression and World War II years that followed.

His benchmarks were quality and service. His motto "Through service we grow." This philosophy was passed on to our father when he ran the company during the mid 1950's until his retirement in 1990 and is still the foundation of our company today.

Little did our grandfather know, when he started his small block company a century ago, his values would be embraced by four generations and that his company would grow beyond local boundaries and earn a reputation as a company of excellence throughout the country and indeed... around the world.

APRIL 1, 1923

Leo Burgoyne starts his block company with one Ideal Hand Tamp Block Machine at Lexington Street in Waltham (300 block per 10 hour day).

1966

Leo's son Joe installs the first automated Columbia block plant at the Waltham location.

1923

1926-1942

Leo adds various hand tamp and brick machines.

1967

Ideal manufactures and ships specialty products to Monrovia, Liberia in West Africa.



1978
Ideal starts production at its second totally automated manufacturing facility in Westford, MA.

1983
John Burgoyne Sr. receives patent on Roofblok ballast system from USPTO.

1986
Ideal begins to manufacture Segmental Retaining Wall Systems.

1975
Ideal is the first company in the United States to produce Lockstone Paving Stones (8000 sf of pavers per day).

1980s
Third generation family members begin to take management roles at Ideal.

1985
Ideal starts production of the first automated Zenith paving plant in the Northeast.

1987
Ideal adds its second automated Zenith production plant increasing overall capacity to 40,000 sf of pavers per day.

OUR HISTORY 100 YEARS 1923-2023



1989

Ideal installs the first robotic paver storage system in the United States.

1993

Ideal becomes a charter member of the newly formed Interlocking Concrete Paving Institute (ICPI) & serves a key role in the leadership of the organization.

1998

Ideal installs the first of three Tumbling Systems.

1991

Ideal begins to market their product line as "Pavers by Ideal."

1997

Ideal begins production with its second production facility for retaining walls in Westford (18,500 block per 8 hour day).

2008

Ideal completes new construction at their original location in Waltham, MA. The building houses a new state of the art indoor and outdoor showroom, training center and a True Value Hardware Store.



2013

Ideal begins marketing an extensive line of natural stone under the name Natural Stone by Ideal.

2018

Ideal introduces Color with 4D Technology.

2010-2015

Fourth generation family members assume leadership roles, expanding Ideal in to the new millennium.

2017

Ideal plays a key leadership role in creating the Northeast Hardscape Expo, an annual tradeshow for professional contractors who install hardscape products in the Northeast.

2023

Ideal celebrates it's 100th anniversary!



OUTDOOR LIVING



THE POSSIBILITIES
are endless





















COLOR 4D PAVERS

The logo features a stylized graphic of three horizontal bars in blue, yellow, and red, followed by the word "Color" in a large, bold, black sans-serif font. Below "Color" is the text "with 4D Technology™" in a smaller, italicized black font.

Color with 4D Technology™

Our advanced 4D Technology incorporates a unique manufacturing process that integrates proprietary ingredients supplemented with in-line treatments that enrich and enhance the appearance. 4D Technology pavers have deeper, richer colors fortified with superior performance against the elements. They are delivered treated and protected from the factory saving added costs, extra steps and wait time incurred when sealer is applied to pavers after an installation is completed. Our 4D Technology protects the surface immediately from UV rays, stains and spills and the effects of acid rain - all while providing color fastness that lasts for years to come!

4D Technology pavers meet and exceed ASTM C936 and CSA 231 standards for interlocking concrete pavers - including freeze-thaw and durability requirements. Unlike sealed or slick pavers, the coefficient of friction is not changed. The surface texture is slip and skid resistant. Efflorescence is no match for the improved surface and matrix of our 4D Technology. The chance of it occurring is far less in 4D Technology pavers.



Improved Stain
& Acid Resistance



Enhanced Color
Tones & Fastness



Advanced Freeze-
Thaw Capability



Efflo-Guard™
Integrated

ADVANCEMENTS

that last

MODERN



ANDOVER COLLECTION™

SMOOTH

FEATURES



- ▶ Comprised as a 5-piece set
- ▶ Smooth Surface enhanced with a fortified finish and minimal chamfered edges
- ▶ 2 3/4" thickness for improved flexural strength and weight bearing capacity
- ▶ Suitable for pedestrian and vehicular traffic limited to personal vehicles
- ▶ Set-Stone Pattern utilizes every stone in the set with an easy-to-follow pattern that gives the appearance of a random layout - simplifies placement, saves time and eliminates waste
- ▶ As a permeable pavement provides 5.5% void space 



5 1/2" x 11" x 2 3/4"
2 pcs/set



11" x 11" x 2 3/4"
2 pcs/set



11" x 16 1/2" x 2 3/4"
1 pc/set



Chatham Blend



Oxford Grey



This product is susceptible to scuffing during installation and snow removal. Protect the surface when transporting and handling. Use a roller compactor or urethane pad attached to the compactor plate when compacting. When removing snow, the height of snow blowers and plows must be raised or a poly blade used on the plow edge.

RUSTIC



ANDOVER COLLECTION™

STONECLEFT

FEATURES



- ▶ Comprised as a 5-piece set
- ▶ Pronounced cleft and sculpted profile that replicates the look of natural stone and a surface enhanced with a fortified finish
- ▶ 2 3/4" thickness for improved flexural strength and weight bearing capacity
- ▶ Suitable for pedestrian and vehicular traffic limited to personal vehicles
- ▶ Set-Stone Pattern utilizes every stone in the set with an easy-to-follow pattern that gives the appearance of a random layout - simplifies placement, saves time and eliminates waste
- ▶ As a permeable pavement provides 5.5% void space 



5 1/2" x 11" x 2 3/4"
2 pcs/set



11" x 11" x 2 3/4"
2 pcs/set



11" x 16 1/2" x 2 3/4"
1 pc/set



Chatham Blend



Oxford Grey



This product is susceptible to scuffing during installation and snow removal. Protect the surface when transporting and handling. Use a roller compactor or urethane pad attached to the compactor plate when compacting. When removing snow, the height of snow blowers and plows must be raised or a poly blade used on the plow edge.

MODERN



ANDOVER 5511™

SMOOTH

FEATURES

- ▶ Surface has a smooth, fortified finish with minimal chamfered edges
- ▶ Use as stand-alone paver, banding or border course for our Andover Collection
- ▶ 2 ¾" thickness for improved flexural strength and weight bearing capacity
- ▶ Suitable for pedestrian and vehicular traffic limited to personal vehicles
- ▶ As a permeable pavement provides 7.5% void space 



5½" x 11" x 2¾"



Chatham Blend



Oxford Grey



Graphite



This product is susceptible to scuffing during installation and snow removal. Protect the surface when transporting and handling. Use a roller compactor or urethane pad attached to the compactor plate when compacting. When removing snow, the height of snow blowers and plows must be raised or a poly blade used on the plow edge.

RUSTIC



PORTSMOUTH COBBLE™

FEATURES



- ▶ Comprised as a 4-piece set with a smooth, cobbled surface and edges enhanced with a fortified finish
- ▶ Length of all 4 sizes, when placed end-to-end, is approx. 28 1/2"
- ▶ Sold by the 6 1/2 sf layer comprised of 6 sets of all 4 sizes
- ▶ Suitable for pedestrian and vehicular traffic limited to personal vehicles
- ▶ Use as a stand-alone paver or accent paver for decorative banding and border courses
- ▶ Can be installed as a traditional or permeab pavement (variable void space)



4 Piece Set
 5.5" x 5.5" x 2 3/4"
 5.5" x 6.65" x 2 3/4"
 5.5" x 7.64" x 2 3/4"
 5.5" x 8.8" x 2 3/4"



Oxford Grey



Graphite



This product is susceptible to scuffing during installation and snow removal. Protect the surface when transporting and handling. Use a roller compactor or urethane pad attached to the compactor plate when compacting. When removing snow, the height of snow blowers and plows must be raised or a poly blade used on the plow edge.

NATURAL INSPIRATIONS

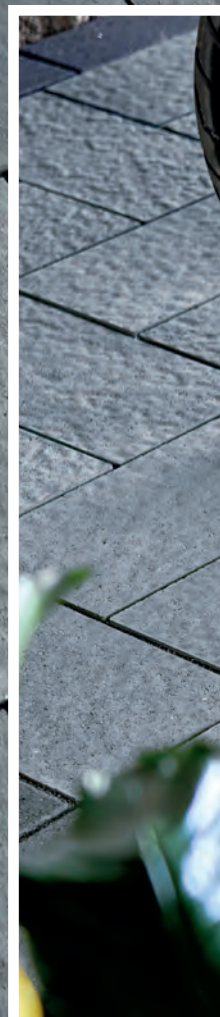

WINDSOR SLAB™

FEATURES



- ▶ Our latest addition to the Color 4D line of pavers
- ▶ Large format style with a thermal like Natural Impression surface, enhanced with a fortified finish
- ▶ Square edge
- ▶ Available in Mineral Blue, an all-new color exclusive to the product
- ▶ "Mix-n-Match" packaging - 3 sizes individually packaged allow multiple pattern choices
- ▶ Small Rectangle suitable for pedestrian and vehicular traffic limited to personal vehicles
- ▶ Large Rectangle and Square limited to pedestrian traffic

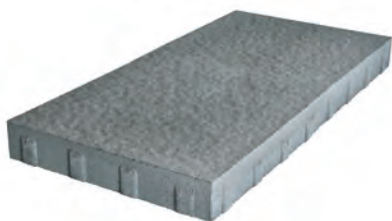

Large Rectangle
16 1/2" x 33" x 2 3/4"

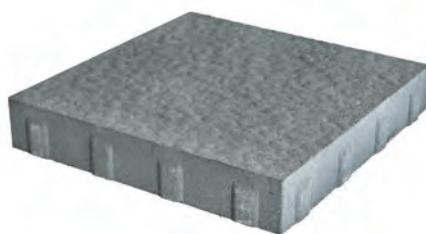

Square
16 1/2" x 16 1/2" x 2 3/4"



Small Rectangle
8 1/4" x 16 1/2" x 2 3/4"



Mineral Blue



This product is susceptible to scuffing during installation and snow removal. Protect the surface when transporting and handling. Use caution not to chip edges when placing with clamp. Roller equipped compactor ONLY to be used when compacting. When removing snow, adjust height of snow blowers to avoid scratching surface. Do NOT plow.

TRADITIONAL PAVERS





PAVERS
with style







CLASSIC



YANKEE COBBLE™

FEATURES

- ▶ Traditional Finish with pressed edges and dimpled surface
- ▶ "Mix-n-Match" packaging - Choice of shape, size and color
- ▶ Circle Pak allows you to integrate circles into your design



Square
6 5/16" x 6 5/16" x 2 3/8"



Large Rectangle
6 5/16" x 9 7/16" x 2 3/8"



Grand Square
9 7/16" x 9 7/16" x 2 3/8"
Only available in Quarry
and Vineyard Blend



New larger diameter of 133 1/2"
* Now available in Graphite



Beacon Hill Blend



Vineyard Blend



Quarry Blend



Graphite



This product is susceptible to scuffing during installation. Use a urethane pad attached to the compactor plate or spread a thin layer of sand or sheet of geotextile fabric over the surface when compacting.

CLASSIC



BOSTON COLONIAL PAVERS®

FEATURES

- ▶ Classic rectangular shape with traditional finish
- ▶ Chamfered edges
- ▶ Patterns include classic 45° and 90° herringbones, running bond, parquets and basketweaves
- ▶ 2 3/8" thickness suitable for pedestrian and vehicular traffic limited to personal vehicles
- ▶ 3 1/8" thickness suitable for commercial vehicular traffic available as MTO only. Please contact your local Ideal dealer for availability

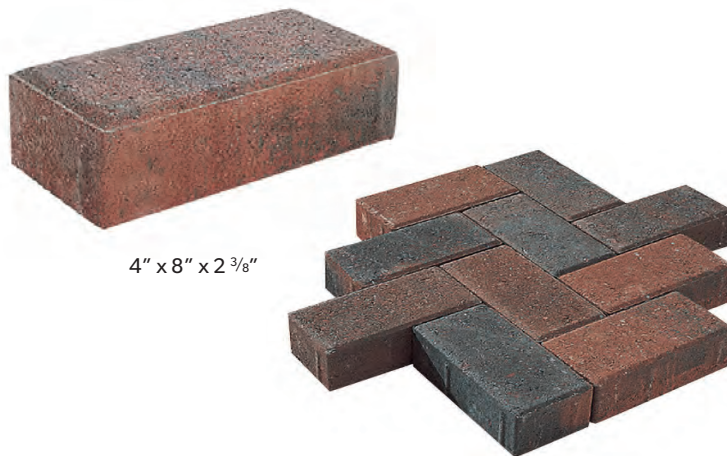

Beacon Hill Blend



Vineyard Blend



Quarry Blend



Graphite



RUSTIC



BROOKSTONE™

FEATURES

- ▶ Traditional finish with 11 different shapes and sizes
- ▶ 2 3/4" thickness
- ▶ Sold by the 12sf layer
- ▶ Mix and Match colors
- ▶ Use alone, as an inset or banding
- ▶ Random placement and patterns
- ▶ Can be used as both traditional and permeable pavement when used with open-graded stone and variable void space 

STANDARD COLORS



Vineyard Blend
Gray Sand



Quarry Blend
Gray Sand



Graphite
Gray Sand



Vineyard Blend
Black Sand



Quarry Blend
Black Sand



Graphite
Black Sand

MIX & MATCH COLORS



Vineyard/Quarry
Gray Sand



Quarry/Graphite
Gray Sand



Graphite/Vineyard
Gray Sand



Vineyard/Quarry
Black Sand



Quarry/Graphite
Black Sand



Graphite/Vineyard
Black Sand



TUMBLER PAVERS



TUMBLER

PAVERS
with style



100 YEARS

RUSTIC

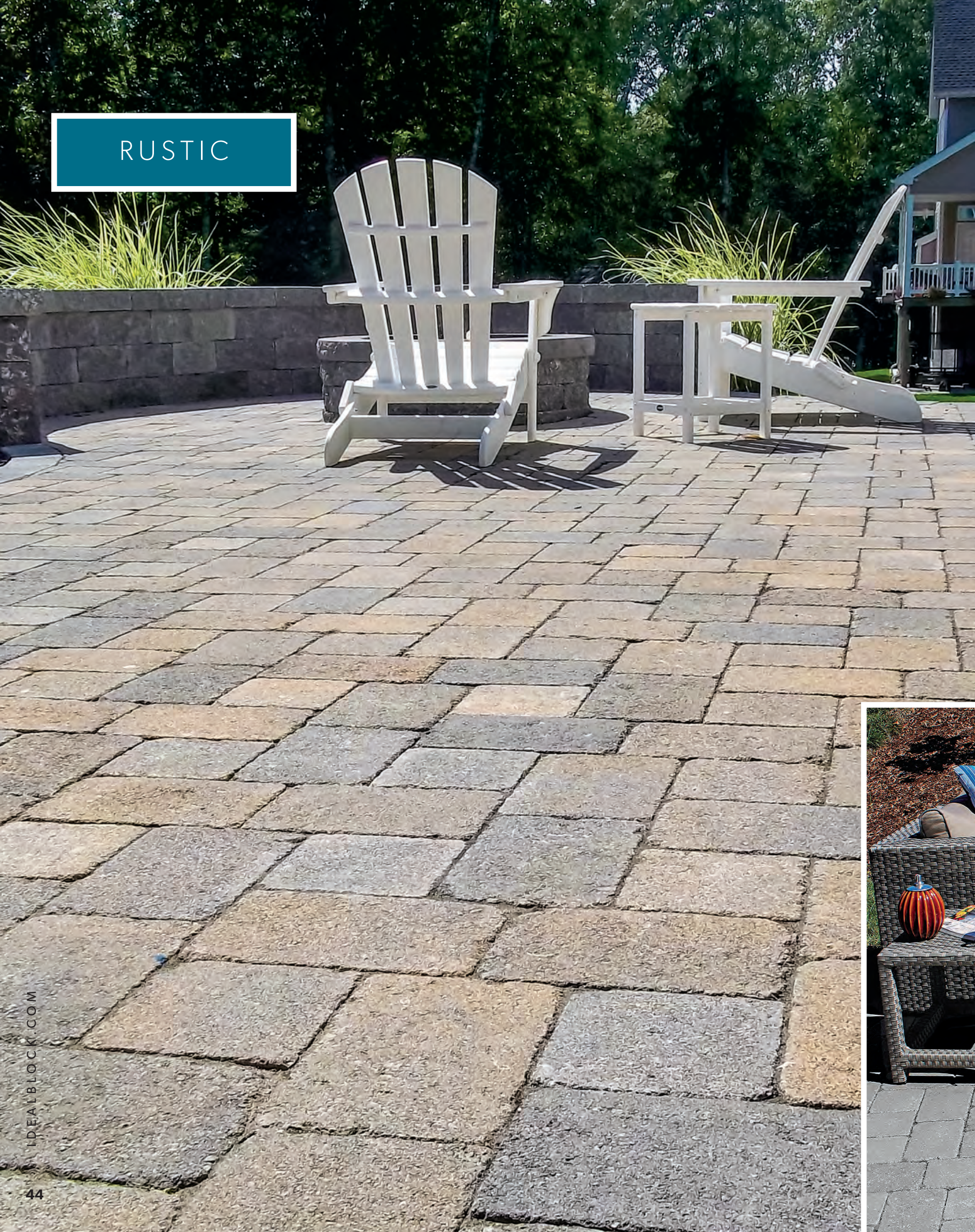

MILLSTONE™



FEATURES

- ▶ Drum-Roll Tumbled Finish with soft patina and weathered tones
- ▶ Mix-n-Match Packaging - Choice of shape, size and color
- ▶ Suitable for pedestrian and vehicular traffic limited to personal vehicles



Square
6 5/16" x 6 5/16" x 2 3/8"



Large Rectangle
6 5/16" x 9 7/16" x 2 3/8"



Quarry Blend



Vineyard Blend



RUSTIC



GEORGETOWN COLONIAL™



FEATURES

- ▶ Classic rectangular shape
- ▶ Drum-Roll Tumbled Finish
- ▶ Flip 'n' Place dual surface - can be laid with chamfer side face up or face down or in any combination
- ▶ Blends can be intermixed to replicate "preservation colors" of "turn-of-the-century" brick
- ▶ Patterns include classic 45° and 90° herringbones, running bond, parquets and basketweaves



4" x 8" x 2 3/8"



Beacon Hill Blend



Quarry Blend



Vineyard Blend



PERMEABLE PAVERS





PERMEABLE

PAVERS
with style

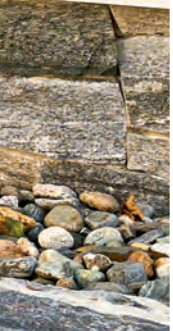

100 YEARS



AQUA-BRIC® & AQUA-BRIC® 8



FEATURES

- ▶ Classic rectangular shape with traditional finish
- ▶ Aqua-Bric is 2 3/8" thick. Suitable for pedestrian and vehicular traffic limited to personal vehicles
- ▶ Aqua-Bric 8 is 3 1/8" thick. Suitable for commercial vehicular traffic. MTO only. Please contact your local Ideal dealer for availability
- ▶ Aqua-Bric 8 is manufactured with both shapes included in a single layer and is sold by the 11.25 sf layer



Aqua-Bric 8
4 1/2" x 9" x 3 1/8"
(28 units per layer)



Aqua-Bric
4" x 8" x 2 3/8"



Aqua-Bric 8
4 1/2" x 13 1/2" x 3 1/8"
(8 units per layer)



Beacon Hill Blend



Quarry Blend



Vineyard Blend





15 RESEARCH DRIVE

LOW-EMISSIONS
FUEL-EFFICIENT
VEHICLES ONLY
ELECTRIC CAR

HANDICAPPED
PARKING

TURFSTONE™



FEATURES

- ▶ Proven environmental design
- ▶ Plant with grass or fill with stone to infiltrate stormwater
- ▶ High strength capable of supporting H-20 heavy vehicle loads
- ▶ Snow-plow safe
- ▶ Can be used on slopes and swales for erosion control
- ▶ Available in 3 1/8" thick or 4" thick.
4" thick MTO only.
Please contact your local Ideal dealer for availability



23 5/8" x 15 3/4"

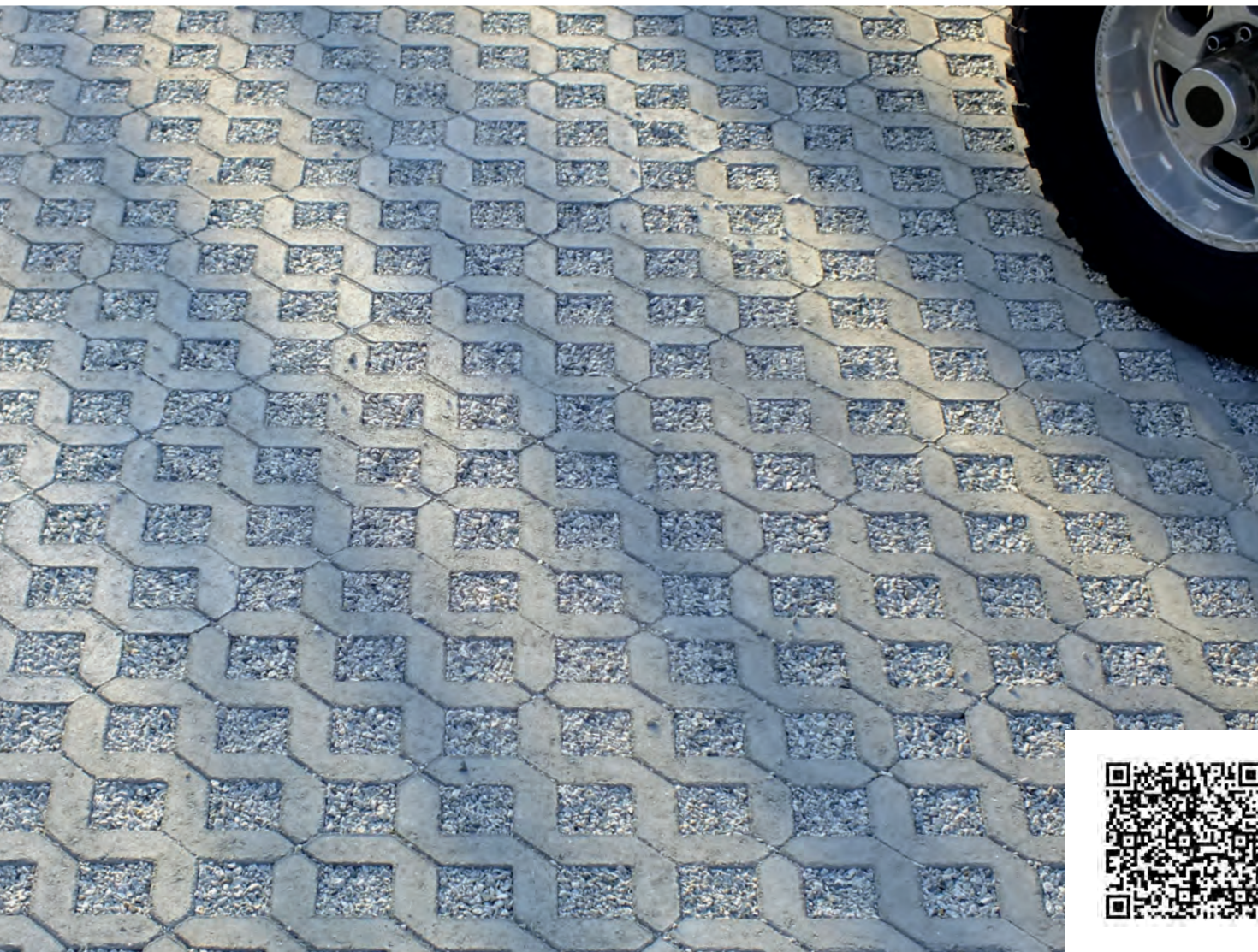

WALLS





WALLS
with style









ANCESTRAL™ WALLSTONE

FEATURES

- ▶ Available in 3" and 6" heights by 10" depth - in 3 lengths (tapered)
- ▶ New slotted design and 3-way alignment plug allow product to batter back, step forward or build straight up with vertical alignment
- ▶ New 16/14" unit designed as Easy Split corner unit
- ▶ New maximum height up to 39" with batter and proper design
- ▶ Versatile design creates straight, curved and serpentine walls, free-standing, double-sided walls, sitting walls, raised planters & low-height retaining walls
- ▶ Use same height unit in wall or combine both to create impressive ashlar patterns

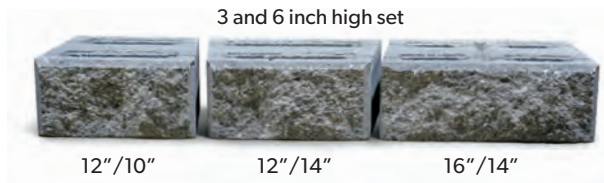

3-way alignment plug



Vineyard Blend



Quarry Blend



Quarry Blend with 3" Graphite band





FAT FACE®

FEATURES

- ▶ One square foot block with split face finish
- ▶ Open-core design optimizes interlock from one course to the next with a "rock-to-rock" connection
- ▶ Create straight, concave, or convex retaining walls
- ▶ Reversible alignment plug creates vertical or battered walls (1" set back per vertical foot)
- ▶ Ideally suited for residential, commercial and municipal walls
- ▶ When properly engineered, walls can be constructed to virtually any height



Fat Face
18"l x 8"h x 11 1/2"d



Reversible Corner Unit
15"l x 8"h x 6"d



Vineyard Blend



Quarry Blend



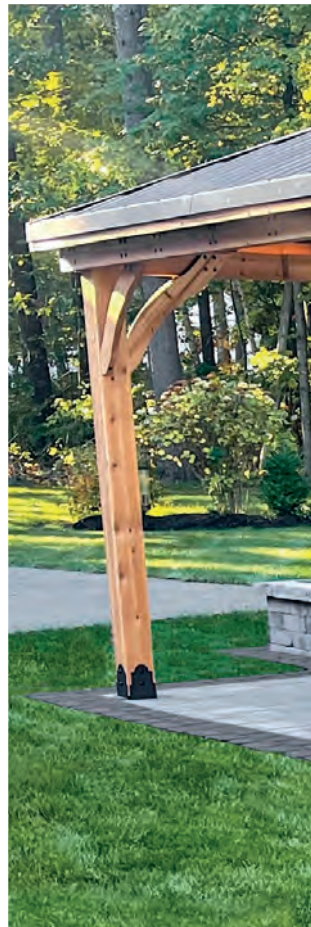

OLDE BOSTON™ WALL



FEATURES

- ▶ Drum-Roll Tumbled Finish
- ▶ Perfect for pillars - free-standing walls - raised planters or low-height retaining walls up to 24" high
- ▶ Placement in four different orientations and can create a variety of patterns - running bond, random, and ashlar
- ▶ Can be field split to create accent banding within the wall



4" h x 12" w x 8" d



Graphite (non-tumbled)



Pewter



Vineyard Blend



Quarry Blend



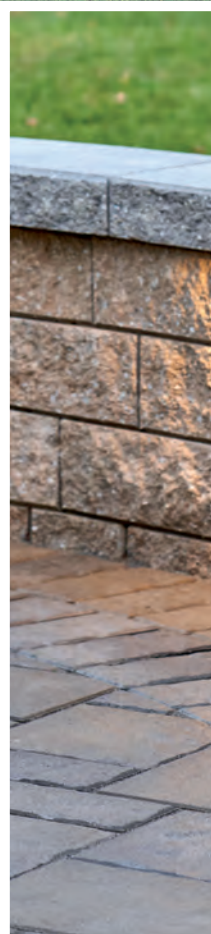

ROMAN PISA®



FEATURES

- ▶ Full component system creates a variety of ashlar patterns, as well as running bond combinations
- ▶ Drum-Roll Tumbled Split Finish
- ▶ Tongue and groove connection (1 1/2" set back per vertical foot)
- ▶ Versatile - use in planter height walls to tall commercial walls



Stretcher
6"h x 8"w x 12"d



Stretcher Cap
6"h x 8"w x 12"d



Half Unit
6"h x 4"w x 12"d



Corner - Reversible
6"h x 8"w x 12"d



Jumbo Unit
6"h x 12"w x 8"d



Vineyard Blend



Quarry Blend

COPING

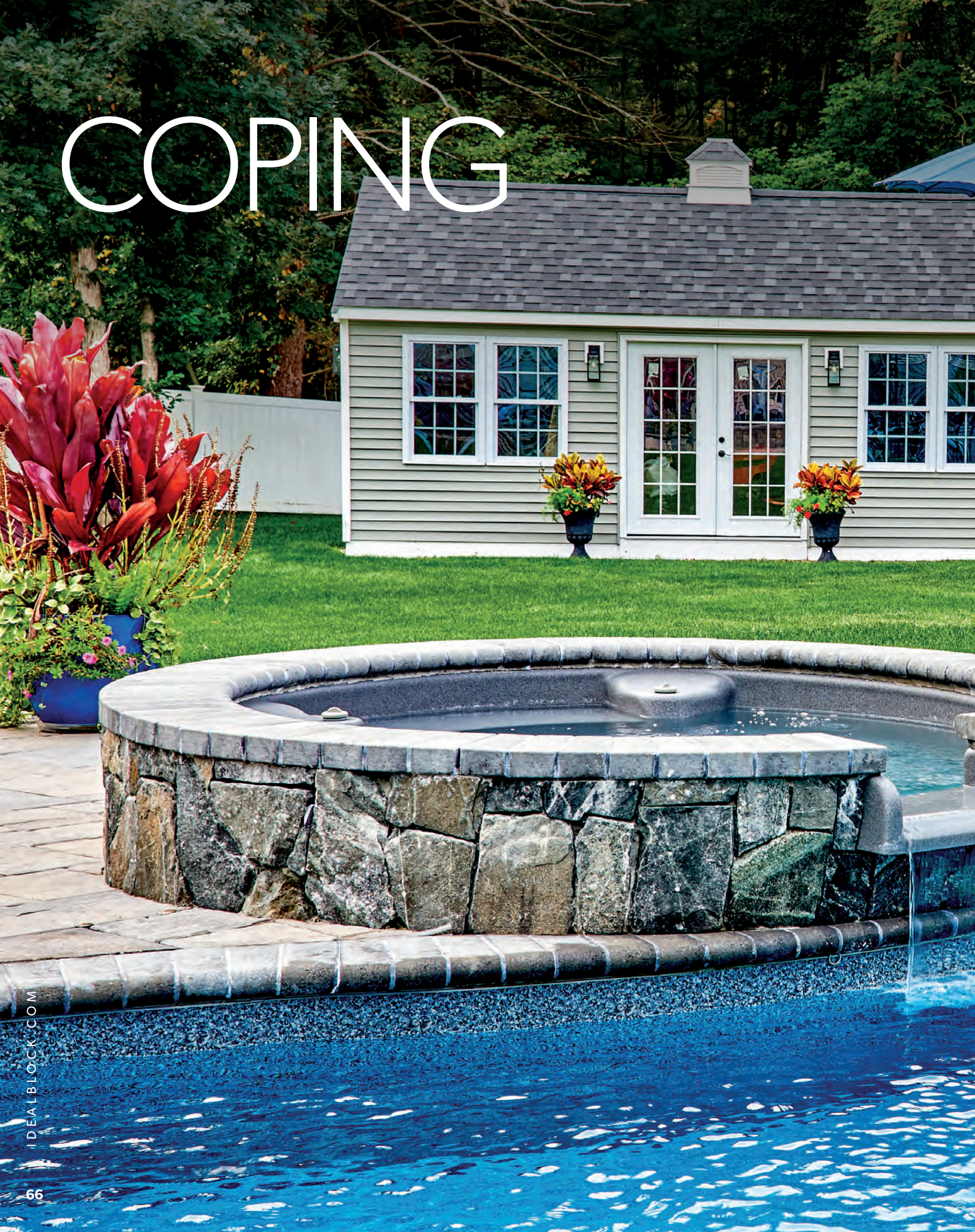



COPING
with style





ANCESTRAL™ COPING



FEATURES

- ▶ Set consists of 2 pieces that are tapered to follow straight, curved or serpentine walls
- ▶ Matching double sided split finish for use on free standing walls
- ▶ Features subtle chamfered edges on top and sides
- ▶ Available in Vineyard Blend, Quarry Blend, and Graphite



Ancestral - 2 Piece Set
3.63" h x 16/13" l x 13" d
3.63" h x 13/10" l x 13" d

UNIVERSAL™ COPING



FEATURES

- ▶ Universal Coping features a Split Finish on one face and a smooth finish on the other – simply position the unit for the look you prefer
- ▶ Perfect for use on Roman Pisa and Fat Face walls
- ▶ Available in Vineyard Blend, Quarry Blend, and Graphite



Universal Coping
3.63" h x 16" w x 13" d



If coping units are used as stair treads that will be subject to deicing chemicals, coping units must be treated with a non-film forming, penetrating-type sealer. See your local Ideal Dealer for more information.



CASTSTONE™ ROCKFACE COPING



FEATURES

- ▶ Ideally suited as coping for our Ancestral or Olde Boston seat walls
- ▶ Natural look Rockface edge along both sides of length
- ▶ The 24" long coping is a best choice for finishing seat walls and topping free-standing, double, sided walls
- ▶ Available in Slate Grey color
- ▶ 14" x 24" available in Graphite

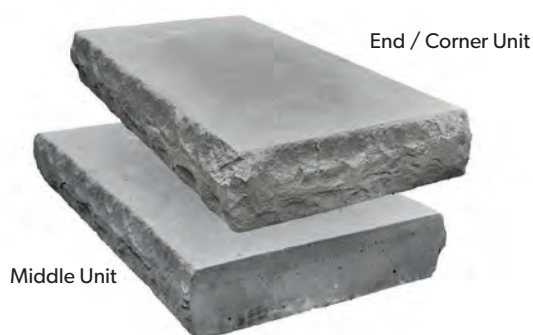

Middle Unit

End / Corner Unit

CastStone Coping 3" h x 24" l x 14" d

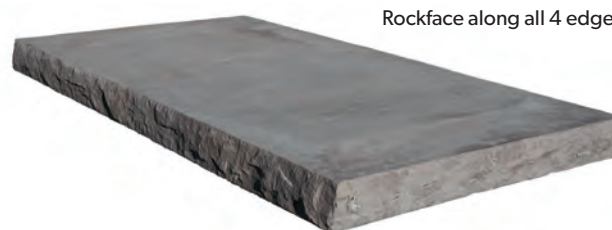

Rockface along all 4 edges

CastStone Coping 3" h x 48" l x 24" d

BULLNOSE COPING™



FEATURES

- ▶ The perfect finishing touch for your pool deck, jacuzzi, or as stair treads, our BullNose Coping complements any of our lines of 2 3/8" high interlocking concrete pavers
- ▶ Available in Quarry Blend and Graphite



4" x 12" x 2 3/8"



Quarry Blend

Graphite

ELEMENTS





FINISHES
with style









ROCKPORT™ STEPS



FEATURES

- ▶ Cast in molds that replicate textures, colors and detail of natural stone
- ▶ Sizes sold individually
- ▶ Features 7" rise
- ▶ Fieldstone Blend color



Step A - 42"l x 18"d



Step C - 48"l x 18"d



Step D - 54"l x 24"d



Step F - 60"l x 18"d

ROCKPORT™ PATHWAY STONES



FEATURES

- ▶ Cast in molds that replicate textures, colors and detail of natural stone
- ▶ Sold as a set consisting of the 3 sizes
- ▶ 2 3/4" Thickness
- ▶ Fieldstone Blend color



RPS A - 25 3/4"l x 18 1/8"d



RPS B - 34"l x 21 7/8"d



RPS C - 30 3/4"l x 22 1/4"d



CARLISLE PILLAR CAP



FEATURES

- ▶ Ideally suited for pillars made from our segmental walls or natural stone
- ▶ Natural look rockface edges
- ▶ Available in Slate Grey and Graphite



24" X 24" X 3"

CHELMSFORD™ STEP



FEATURES

- ▶ Choice of two faces in a single unit
- ▶ One face reproduces a traditional Feather and Wedge style while opposite face features a more contemporary Rockface style
- ▶ Easily build steps that beautifully integrate with our wall systems
- ▶ Features 7" rise
- ▶ Available in Slate Grey color



Rockface side
48"l x 15"d



Feather and Wedge side
48"l x 15"d



SCAPESTONE™ & SCAPESTONE™ XL FIRE PIT

- ▶ ScapeStone - 30" inside diameter/44" outside
- ▶ ScapeStone XL - 44" inside diameter/60" outside
- ▶ Requires heavy-duty steel frame or gas insert
- ▶ Optional CastStone Coping available



DIMENSIONS & COVERAGE

ScapeStone FP Block	4"h x 12"l x 6"d	11/course	20 lb ea
Round Ring Insert	30" dia x 8"h	---	34 lb
Round Ring-n-Grate	30" dia x 8"h	500 sq in	67 lb

ScapeStone XL Block	4"h x 12 3/8"l x 6 1/4"d	14/course	22 lb ea
Round Ring	44" dia x 8"h	---	50 lb



Quarry Blend



Vineyard Blend

CASTSTONE COPING



CastStone Round Coping
ScapeStone Available in Slate Grey and Graphite
ScapeStone XL Available in Slate Grey



CastStone Square Coping
Available in Slate Grey
and Graphite

STEEL INSERT OPTIONS



Round Ring
ScapeStone & ScapeStone XL



Round Ring-n-Grate
ScapeStone



Square
Olde Boston Wall & Roman Pisa
*Bolt Assembly



OLDE BOSTON™ FIRE PIT

- ▶ Olde Boston - 28" inside diameter/44" outside
- ▶ Requires heavy-duty steel frame or gas insert
- ▶ Optional CastStone Coping available



DIMENSIONS & COVERAGE

Olde Boston Wall Block	4" h x 12" l x 8" d	12/course	28 lb ea
Square Frame Insert	27 1/2" x 27 1/2" x 8" d	---	35 lb



Quarry Blend

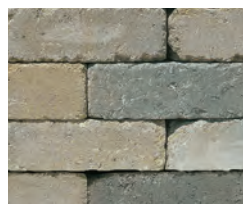

Vineyard Blend



Pewter



Graphite (non-tumbled)

ROMAN PISA® FIRE PIT

- ▶ Roman Pisa - 28" inside diameter/44" outside
- ▶ Requires heavy-duty steel frame or gas insert
- ▶ CastStone Coping required



DIMENSIONS & COVERAGE

Roman Pisa Jumbos	6" h x 12" l x 8" d	8/course	32 lb ea
Roman Pisa Corners	6" h x 12" l x 8" d	4/course	32 lb ea
Square Frame Insert	27 1/2" x 27 1/2" x 8" d	---	35 lb
CastStone Coping	10" w x 38 1/2" l x 3" h	4 pcs	99 lb ea



Quarry Blend



Vineyard Blend



Gas inserts are a great way to elevate your fire pit to the next level! Our fire pits are universally sized and can be used with many gas insert manufacturers' kits. Contact us or your local Ideal dealer for more information.

KING OF HEARTHS





KING OF HEARTHS

OUTDOOR FIREPLACES & OVENS

KING OF HEARTHS



HEARTHS

with style

100 YEARS

KING OF HEARTH'S

Few things are as enjoyable as spending time with family and friends in your own backyard. Our line of King of Hearths outdoor fireplaces and oven make it easier than ever before to add to that experience with the warmth and glow of a crackling fire, the savory taste of delicious pizza or roasted meat with flavorful vegetables cooked in a wood-fired oven.

King of Hearths pre-cast fireplace and oven with open side boxes are pre-built, ready to set-up. The fireplaces are lined with fire brick and come pre-assembled, as do the oven and side boxes. The units are ready to be placed, stacked and veneered with natural stone, brick or our Olde Boston™ WallStone. Whether you are building a new outdoor living space or adding to an existing one, you can feel confident knowing King of Hearths products have been engineered with high strength concrete made to stand the test of time and rigors of New England's weather!



KING ARTHUR FIREPLACE

46" OUTDOOR FIREPLACE

- ▶ Simple 3-piece mortarless design makes set up quick and easy
- ▶ Fire box pre-lined with fire brick
- ▶ Ready to be finished with natural stone veneer
- ▶ Large fire box opening
- ▶ Built-in fork pockets facilitate lifting into place
- ▶ Sets on a 6" thick concrete slab 50" w x 40" d
- ▶ Chimney sized to accept 13" x 13" spark arrestor (sold separately)
- ▶ Cast Iron Log Grate included
- ▶ Weight: 2100 lbs
- ▶ Stone veneer: 63 sq ft
- ▶ Stone veneer corners: 36 lin ft

Note: Unit must be veneered. Prior to veneering, it must be "seasoned" by lighting several small fires.

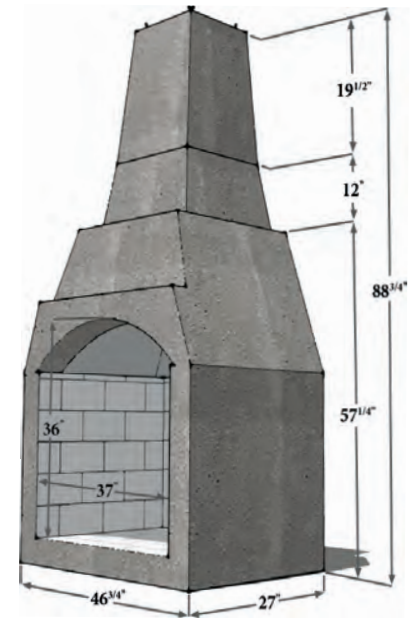

Natural Stone
by Ideal®



GUINEVERE FIREPLACE

38" OUTDOOR FIREPLACE

- ▶ Simple 2-piece mortarless design makes set up quick and easy
- ▶ Fire box pre-lined with fire brick
- ▶ Ready to be finished with natural stone veneer
- ▶ Built-in fork pockets facilitate lifting into place
- ▶ Sets on a 6" thick concrete slab 42" w x 32" d
- ▶ Chimney sized to accept 13" x 13" spark arrestor (sold separately)
- ▶ Cast Iron Log Grate included
- ▶ Weight: 1700 lbs
- ▶ Stone veneer: 46 sq ft
- ▶ Stone veneer corners: 28 lin ft

Note: Unit must be veneered. Prior to veneering, it must be "seasoned" by lighting several small fires.

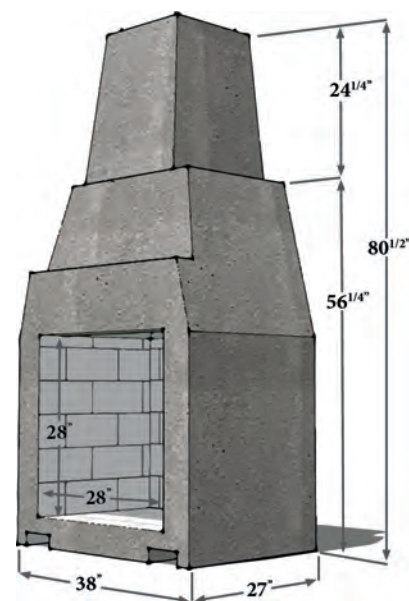

LANCELOT OVEN

- ▶ Great for stone fired pizzas and more
- ▶ Protective fire brick pre-installed
- ▶ Chimney sized to accept 9" x 9" spark arrestor (sold separately)
- ▶ Ready to be finished with natural stone veneer
- ▶ Weight: 2,000 lbs
- ▶ Stone Veneer: 26-30 sq ft
- ▶ Stone Veneer Corners: 18 lin ft

Note: Unit must be veneered. Prior to veneering, it must be "seasoned" by lighting several small fires.

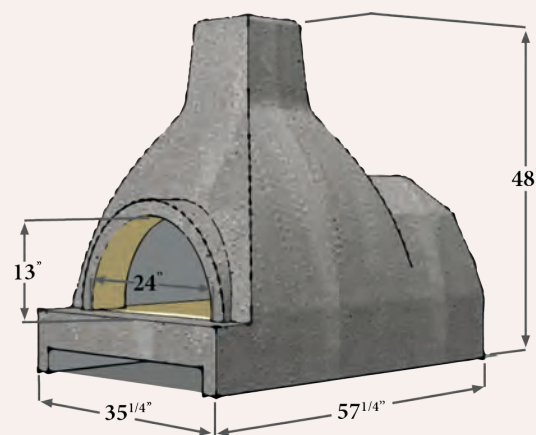

REVERSIBLE SIDE STORAGE BOX

- ▶ Attractive side box doubles as a storage cabinet for wood and counter surface
- ▶ Installs easily – no mortaring necessary
- ▶ Reversible unit – sized to fit each side of the fireplace
- ▶ Ready to be finished to match fireplace exterior

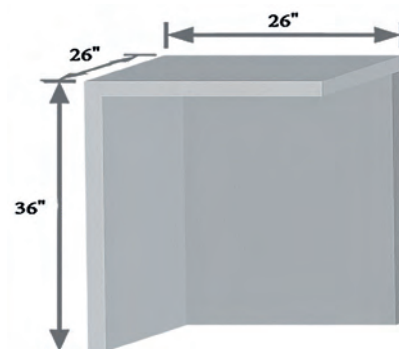

NATURAL STONE



Natural Stone
by **Ideal**[®]



STONE
with style







NATURAL STONE VENEER

Ideal's natural stone veneer is the perfect upgrade for your home. Whether you want to make a statement by facing the front of your home or upgrade the appearance of existing steps, we have the answers.

Natural Stone
by Ideal®

EXCLUSIVE BLENDS



Natural Rounds



Natural Mosaic



Mountain Mist Mosaic

CONNECTICUT GRAY



Ashlar



Mosaic



Ledgestone



Square & Rectangle

CONNECTICUT TAN

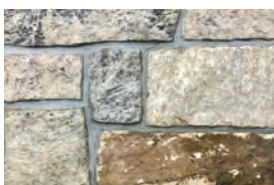

Ashlar

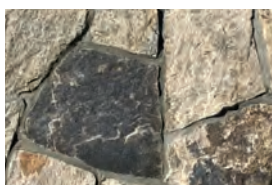

Mosaic

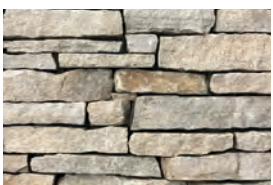

Ledgestone



Square & Rectangle

NEW ENGLAND BLEND



Ashlar



Mosaic



Ledgestone



Square & Rectangle

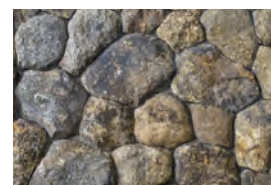

Rounds

DIMENSIONS & COVERAGE

Exclusive Blends, CT Gray, CT Tan, & New England Blend

Thin Veneer Flats	+/- 1.5" Thickness	10 sf/layer	160 sf/pallet
Thin Veneer Corners	+/- 1.5" Thickness	By the lf	50 lf/pallet
Full Bed Depth	4" - 6" Thickness	By the tn	1.5 tn/pallet*

*(Approx. 35-40 sf/tn)



Thin veneer corners available in all colors and shapes



We strongly recommend using an experienced craftsman to achieve the look shown on these pages. The stones have been professionally shaped and trimmed to fit tightly together. This often requires more material, so be sure to take this into consideration when placing your order.





GRANITE & BLUESTONE

Granite and bluestone are among New England's signature natural stones and have been used for hundreds of years in residential, commercial, and municipal projects for its beauty and durability. From cobbles and edging to stairs, posts, coping, and slabs, we offer a complete line of products to suit any project.



GRANITE

- ▶ Choose from in stock colors, such as Salt & Pepper and Blue Mist, as well as a variety of special order colors
- ▶ Available in steps, treads, pattern stock and more
- ▶ Offered in a variety of finishes, including thermal, split and rock face



Salt & Pepper Granite



Blue Mist Granite



Granite Steps



Granite Treads



American Granite Slabs

BLUESTONE

- ▶ Choose from in stock colors PA Blue and Full Color
- ▶ Available in treads, pattern stock and more
- ▶ Offered in Thermal and Natural Cleft finishes



Thermal Finish

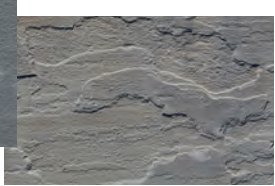

Natural Cleft Finish

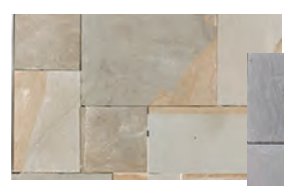

Full Color

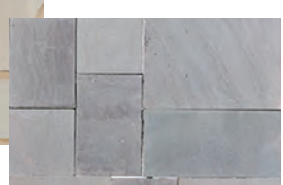

PA Blue



Treads
Top: Blue Mist Granite
Middle: Salt and Pepper Granite
Bottom: Bluestone

GRANITE COBBLES



Grey

- 7 x 10 x 4 in. - Jumbo
- 6 x 12 x 3 in. - Footlong
- 6 x 6 x 3 in. - Half Footlong
- 5 x 9 x 5 in. - Regular
- 4 x 8 x 4 in. - Landscape
- 4 x 4 x 4 in. - Cube



Jumbo Grey Cobbles



BULK & PALLETIZED STONE



Step out of the box and explore our bulk and palletized stone. We offer irregular stone, risers, and palletized wallstone in addition to timeless New England Round Stone.

Natural Stone
by Ideal®



PA Natural



Colonial Grey



Weathered Fieldstone



New England Natural Rounds (Ideal Exclusive)



Connecticut Tan Wallstone



Connecticut Gray Wallstone



Colonial Grey Risers



Full Color Irregular Flaggng

MEETING YOUR EXPECTATIONS

As you consider a new walkway, patio, driveway, landscape wall, or other hardscape project, you have lots of choices as to which product and color to select. It's an important decision. After all, it's an investment that should meet your expectations for years to come. So we thought it would be helpful and responsible to pass along some sound advice.

What should be realistic expectations for your pavement or wall? Our pavers, walls and garden products are commercial grade – unlike similar products found in large home improvement stores. Ours are factory made and delivered in ready-to-use condition that meets the highest industry standards. This means they are strong, dense and durable. Properly installed, your pavement and landscape walls will provide years of lasting beauty and dependable performance!

Ideal has made and sold hundreds of millions of paving stones and countless landscape walls since 1975. In fact, no other manufacturer has sold more in New England than Ideal. Our name has become synonymous with quality, service and reliability. While some manufacturers would lead you to believe their pavers and walls will never change in appearance, we believe in a more realistic position. After all, over time Mother Nature takes her toll on everything! We keep this in mind in our design. So while normal wear and tear and exposure to the elements are part of the natural aging process, you can expect the color tones, shape and pattern of Ideal products to remain for a lifetime!

Colors: Our Beauty is More Than Skin Deep

Our pavers and walls are saturated with rich colors...top-to-bottom... not just at the surface. Because color is throughout, chips, dings and scratches, which are inevitable, quickly "blend-in" and are hardly discernible. Don't be fooled by products where color is concentrated only in the thin veneer. After all, our products are a lifetime investment.



Our Process: It's Only Natural

Our pavers and walls are made with natural ingredients. Look closely and you will find a unique character to each and every paver and wall. In fact, no two look exactly alike. You will see subtle variations in color and texture for a truly natural appearance. Our color blends contain two or more pigments to achieve a random variegation and even our solid colors have nuances in tone and hue. Please remember that, unlike a painted surface, concrete products have inherent texture and shade variations. The product you receive may vary in color and texture from samples. Cubes of product may contain a different percentage of colors and textures than shown in this catalog. As you would with dye lots in fabric and carpet, purchase your pavers and walls all at one time. When installing, select product randomly and simultaneously from several cubes for uniform color distribution.

Tumbled or Traditional: We come close to fooling mother nature

We manufacture our pavers and walls with a choice of finishes. Choose pavers with a traditional surface or ones with the look and feel found in vintage pavements. From our wall collection select styles with a rugged split face or our tumbled finish that resembles handcrafted walls of yesteryear. To faithfully reproduce the color, texture and durability of vintage stone, we use an innovative technology that enables us to impart an "old world" charm using a unique factory process that antiques the surface, while preserving the inherent structural stability. We call it Genuine Drum-Roll Tumbled, and although it takes more time and effort than automated processes used by other manufacturers, it creates pavers and wallstones that truly capture the nostalgia of time-honored colors and textures of natural materials.



A Picture is Worth a Thousand Words

How true the saying is that a picture conveys an image that words can never describe. That is why we use pictures generously throughout this catalog to depict our products. And yet many factors influence one's perception of images and colors, and they may appear different from one photo to the next. Angle of light and time of day greatly affect perception, and colors printed in ink cannot exactly match the actual concrete product colors. The point we are trying to make is the images shown in this catalog are only the first step in selecting colors. Once you have narrowed your choices, obtain actual samples from your dealer or contractor. View them in the setting where they will be installed before making your final selection.

Efflorescence

A white haze known as efflorescence sometimes appears on the surface of concrete and masonry products. Technically known as calcium hydroxide, it can come from a number of sources and appears as a white film when carried to the surface by moisture. It may appear randomly or in certain areas and is more pronounced on darker colors. The good news is efflorescence does not affect longevity or structural performance. Although unsightly when it first appears, in many cases it is scoured off during installation, or if desired, it can be removed using specialty cleaners. Otherwise, it will typically lessen, or dissipate, over time with rain, snow and wear.

Because efflorescence can be a natural by-product of cement hydration, its presence is not indicative of a flawed or defective product. We, as do all other manufacturers, disclaim it from our warranty.

Lifetime Warranty

We back our pavers and walls with our Name and a Lifetime Warranty on the structural integrity of our products used in residential applications. Product that proves to be defective by failing to meet ASTM industry standards will be replaced without cost. We will do our best, but color, texture and finish of replacement product may not match the original, and cost of labor is not included. Proof of purchase is required. All warranty claims must be made prior to removal or disposal of product in question and be approved in writing. Please note, color variance and efflorescence do not constitute an actionable claim against our warranty. Other exclusions apply. Please visit www.IdealBlock.com/warranty for complete details.

Snow, Ice and Deicers

Our pavers and walls are more than beautiful. They have the strength and durability to withstand New England's harsh winters and, when properly installed, snow removal is no problem...either by shovel, snow blower or a plow using a rubber or poly plastic cutting edge.

The surface of our pavers is slip and skid resistant even when wet. Ice, on the other hand, can be slippery, particularly as it melts, and common sense should be used to prevent slips and falls. We recommend sand for traction. It can be applied liberally and as often as needed. Sand provides a visual reference of its presence and can be felt underfoot as a tangible medium aiding foot traffic. Clean, untreated sand has no corrosive effect on steel, metal, clay brick, cast-in-place concrete or concrete pavers and it can be swept into the paver joints or removed by conventional sweeping or vacuuming.

Concrete pavers are exceptionally robust in resisting the effects of deicing chemicals. We have manufactured pavers that have been exposed to salts for over 45 years! Nevertheless, chlorides can be harmful to concrete, steel and other building materials depending on the type, concentration and frequency of application. If using a deicer, we recommend a NaCl sodium chloride. We strongly advise against the use of other types, particularly magnesium and potassium chloride, and products that contain a blend of these chemicals.

Read Me

Throughout our catalog, this icon is displayed with a variety of products. It is our way of pointing out essential instructions unique to the particular paver to assure the best outcome when transporting, handling, installing and removing snow from the pavers.



While all pavements experience wear and tear over time, a little care and attention go a long way to avoid marring the surface early on. Protect the faces from abrasions and scratches that occur when units are slid across the top of the layer below. Do not drop them. Most important, stipulate that a urethane pad be attached to the plate of the compactor when it is run over the pavers to avoid scuffing the surface - particularly for styles with embossed and clefted faces. Do not overlook snow removal. Take precautions that the height of snow blowers and plow blades are adjusted or a poly blade is used on plow edge. Surface scratches are not covered by our warranty. If unsure what should be done, identification tags attached to every cube when the product is delivered provide the information you need to know.

Visit Our Website to Learn More

We invite you to visit our website IdealBlock.com. It offers a wealth of information including:

- Where to buy
- Wall Guide to selecting the best style
- Photo gallery
- Technical specifications
- Easy to follow how-to instructions
- Contractor Paver and Wall Guides
- Product literature
- Cross sections and drawings
- Paver and Wall Comparison Charts
- Case studies
- Patterns
- Cleaning and sealing guide



Color & Product Packaging Directory

Please note: Product offerings may change during the year. Please visit IdealBlock.com for the most up-to-date Color and Product Packaging Directory information.

Affiliated Organizations

Ideal proudly supports ICPI, NECMA, and NHExpo by taking an active leadership role in developing standards and best practices that serve to advance the industry for its members, community, and constituency.



PHOTO LEGEND

Front Cover – Pavers: Andover Collection Smooth Oxford Grey with Andover 5511 Graphite and BrookStone Quarry Blend ■ Fire Pit Coping: CastStone Coping Graphite

Back Cover – Pavers: Andover Collection Smooth Oxford Grey with Andover 5511 Graphite ■ Fire Pit Coping: CastStone Coping Graphite

Page 3 – Wall: Fat Face Quarry Blend with Universal Coping Graphite

Page 8 & 9 – Pavers: Andover Collection StoneCleft Oxford Grey with Yankee Cobble Circle Pak Quarry Blend ■ Fire Pit: ScapeStone XL Fire Pit Vineyard Blend with CastStone Coping Slate Grey ■ Pillars: Roman Pisa Vineyard Blend with Carlisle Pillar Cap Slate Grey ■ Seat Wall: 6" Ancestral WallStone & Coping Vineyard Blend

Page 10 & 11 – Pavers: Andover Collection StoneCleft Chatham Blend with Andover 5511 StoneCleft Chatham & Oxford Blends* ■ Wall: 6" Ancestral WallStone Vineyard Blend with Ancestral Coping Quarry Blend ■ Pillar: Roman Pisa Pillar Vineyard Blend with Carlisle Pillar Cap. *Pavers sealed with wet look sealer.

Page 12 & 13 – Pavers: Andover Collection Smooth Oxford Grey with Andover 5511 Smooth Graphite ■ Wall: 3" & 6" Ancestral WallStone & Coping Quarry Blend. ■ Hot tub: 3" & 6" Ancestral WallStone Quarry Blend with Bluestone Coping

Page 14 & 15 – Pavers: Andover Collection Smooth Chatham Blend and Oxford mix with Andover 5511 Smooth Graphite ■ Fire Pit: ScapeStone Fire Pit Quarry Blend with CastStone Coping Slate Grey.

Page 16 & 17 – Pavers: Andover Collection StoneCleft Chatham Blend with Andover 5511 StoneCleft Chatham & Oxford Blends* ■ Wall: 6" Ancestral WallStone Vineyard Blend with Ancestral Coping Quarry Blend ■ Pillar: Roman Pisa Pillar Vineyard Blend with Carlisle Pillar Cap Slate Grey. * Pavers sealed with wet look sealer.

Page 18 – Pavers: Andover Collection StoneCleft Oxford Grey with Andover 5511 Smooth Graphite.

Page 19 – Pavers: Andover Collection Smooth Oxford Grey with Andover 5511 Smooth Graphite accent band ■ Natural Stone

Page 20 – Pavers: Windsor Slab Mineral Blue Pattern 1 with Andover 5511 Smooth Graphite.

Page 21 – Pavers: Andover Collection Smooth Oxford Grey with Andover 5511 Smooth Graphite ■ Wall: 6" Ancestral WallStone Vineyard Blend.

Page 22 – Pavers: Andover Collection Smooth Oxford Grey with Andover 5511 Graphite and Oxford Grey.

Page 23 – Inset Picture: Pavers: Andover Collection Smooth Oxford Grey

Page 24 – Pavers: Andover Collection StoneCleft Oxford Grey with Andover 5511 Graphite banding ■ Wall: 6" Ancestral WallStone Quarry Blend with CastStone Rockface Coping Slate Grey ■ Pillar: Roman Pisa Pillar Quarry Blend with Olde Boston Wall Graphite Accent and Carlisle Pillar Cap Slate Grey.

Page 25 – Inset Picture: Pavers: Andover Collection StoneCleft Chatham Blend with Portsmouth Cobble Graphite and Oxford Grey

Page 26 – Pavers: Andover 5511 Smooth Oxford Grey and Graphite Mix 45° Herringbone with Andover 5511 Smooth Graphite sailor course

Page 27 – Inset Picture: Pavers: Andover Collection StoneCleft Chatham Blend with Andover 5511 Graphite

Page 28 – Pavers: Andover Collection StoneCleft Chatham Blend with Portsmouth Cobble Graphite and Vineyard Blend

Page 29 – Inset Picture: Pavers: Portsmouth Cobble Graphite with Andover Collection Smooth Oxford

Page 30 – Pavers: Windsor Slab Mineral Blue Pattern 1 with Andover 5511 Smooth Graphite ■ Wall: 6" Ancestral WallStone Vineyard Blend with Ancestral Coping Graphite

Page 31 – Inset Picture: Paver: Windsor Slab Small Rectangle Mineral Blue 90° Herringbone.

Page 32 – Pavers: Yankee Cobble Quarry Blend Pattern 6

Page 33 – Pavers: Yankee Cobble Vineyard Blend Pattern 4 with Boston Colonial Graphite Band and Yankee Cobble CirclePak Vineyard Blend with Yankee Cobble Graphite accent course.

Page 34 – Pavers: Yankee Cobble Quarry Blend Pattern 6 with Yankee Cobble Square Graphite border

Page 35 – Pavers: Brookstone Quarry Blend and Andover Collection Smooth Oxford Grey with Andover 5511 Smooth Graphite and Oxford Grey ■ Fire Pit: ScapeStone Fire Pit Quarry Blend ■ Wall: Fat Face Quarry Blend with Universal Coping Graphite.

Page 36 – Pavers: Yankee Cobble Vineyard Blend Pattern 6 with Yankee Cobble Square Quarry Blend Interblend.

Page 37 – Inset Picture: Pavers: Yankee Cobble Quarry Blend Pattern 6 with Yankee Cobble Large Rectangle Quarry Blend sailor course

Page 38 – Pavers: Boston Colonial Pavers Quarry Blend 90° Herringbone with Millstone Quarry Blend sailor course ■ Cobblestone Border ■ Steps: Stanstead Granite Rockface Steps

Page 39 – Inset Picture: Pavers: Boston Colonial Vineyard Blend 90° herringbone with Graphite Banding

Page 40 – Pavers: BrookStone Quarry Blend ■ Fire Pit: ScapeStone Fire Pit Quarry Blend

Page 41 – Inset Picture: Pavers: BrookStone Vineyard & Quarry Blend with Granite Cobbles

Page 42 – Pavers: Georgetown Colonial Quarry Blend running bond

Page 43 – Pavers: MillStone Vineyard Blend Pattern 6

Page 44 – Pavers: MillStone Vineyard Blend Pattern 6 ■ Wall: 6" Ancestral Quarry Blend

Page 45 – Inset Picture: Pavers: MillStone Quarry Blend Pattern 6 ■ Fire Pit: ScapeStone Fire Pit Vineyard Blend ■ Wall: 3" & 6" Ancestral Wall & Coping Quarry Blend

Page 46 – Pavers: Georgetown Colonial Quarry Blend 90° Herringbone ■ Steps: Stanstead Granite Rockface Steps

Page 47 – Inset Picture: Pavers: Georgetown Colonial Beacon Hill Blend Running Bond with Yankee Cobble Quarry Blend border ■ Steps: Stanstead Granite Rockface Steps

Page 48 – Pavers: Aqua-Bric Quarry Blend 45° Herringbone Pattern with Boston Colonial Pavers Quarry Blend ■ Natural Stone

Page 49 – Pavers; Aqua-Bric Vineyard Blend 45° Herringbone Pattern

Page 50 – Pavers; Aqua-Bric Quarry Blend 90° Herringbone Pattern ■ Natural Stone

Page 51 – Inset Picture: Pavers: Aqua-Bric Vineyard Blend 90° Herringbone Pattern with Boston Colonial Pavers Vineyard Blend soldier course

Page 52 – Pavers: Turfstone Pewter

PHOTO LEGEND

Page 53 – Inset Picture: Pavers: Turfstone Pewter with crushed stone infill

Page 54 – Wall: Roman Pisa Quarry Blend Running Bond with Universal Coping & Stair Treads Quarry Blend

Page 55 – Wall: 6" Ancestral WallStone Quarry Blend with CastStone Coping Slate Grey ■ Pillar: Roman Pisa Pillar Quarry Blend with Carlisle Pillar Cap Slate Grey.

Page 56 & 57 – Wall: Fat Face Quarry Blend with Universal Coping Graphite ■ Step: Stanstead Granite Rockface Steps

Page 58 – Pavers: Andover Collection StoneCleft Chatham Blend with Andover 5511 StoneCleft Chatham & Oxford Blends* ■ Wall: Ancestral WallStone 6" Vineyard Blend with Ancestral Coping Quarry Blend. *Pavers sealed with wet look sealer.

Page 59 – Inset Picture: Pavers: Windsor Slab Mineral Blue Pattern 1 with Andover 5511 Smooth Graphite sailor course ■ Wall: 6" Ancestral WallStone Vineyard Blend with Ancestral Coping Graphite.

Page 60 – Wall: Fat Face Quarry Blend with Universal Coping Graphite.

Page 61 – Inset Picture: Wall: Fat Face Vineyard Blend with Universal Coping Vineyard Blend.

Page 62 – Pavers: Andover Collection Smooth Oxford Grey ■ Fire Pit: Olde Boston Fire Pit Quarry Blend with Caststone Coping Slate Grey ■ Seat Wall: Olde Boston Wall Quarry Blend with Bluestone Coping

Page 63 – Inset Picture: Kitchen Island: Olde Boston Wall Quarry Blend ■ Pavers: Andover Collection Smooth Oxford Grey with Portsmouth Cobble Graphite

Page 64 – Wall: Roman Pisa Quarry Blend Running Bond with Universal Coping Quarry Blend ■ Pavers: Andover Collection Smooth Oxford Grey with Andover 5511 Graphite ■ Step: Stanstead Granite Rockface Steps

Page 65 – Inset Picture: Pavers: Andover Collection StoneCleft Chatham Blend with Andover 5511 StoneCleft Chatham & Oxford Blends* ■ Wall: 6" Ancestral WallStone Vineyard Blend with Ancestral Coping Quarry Blend ■ Pillar: Roman Pisa Vineyard Blend with Carlisle Pillar Cap Slate Grey. *Pavers sealed with wet look sealer.

Page 66 – Pavers: Andover Collection StoneCleft Chatham Blend ■ Pool & Hot Tub Coping: Bullnose Coping Quarry Blend ■ Natural Stone

Page 67 – Inset Picture: Pavers: Andover Collection StoneCleft Chatham Blend with Andover 5511 StoneCleft Chatham & Oxford Blends* ■ Wall: 6" Ancestral WallStone Vineyard Blend with Ancestral Coping Quarry Blend ■ Pillar: Roman Pisa Vineyard Blend with Carlisle Pillar Cap Slate Grey. *Pavers sealed with wet look sealer.

Page 68 Top – Pavers: Andover Collection StoneCleft Chatham Blend with Andover 5511 Smooth Graphite double sailor course ■ Wall: 6" Ancestral Wall & Coping Vineyard Blend

Page 68 Bottom – Pavers: Yankee Cobble Quarry Blend Pattern 6 with Yankee Cobble Large Rectangle Graphite border ■ Wall: Fat Face Quarry Blend with Universal Coping Quarry Blend.

Page 70 Top – Pavers: Brookstone Quarry Blend and Graphite with Yankee Cobble Square Graphite border ■ Wall: 6" Ancestral WallStone Quarry Blend with CastStone Rockface Coping Graphite

Page 70 Bottom – Coping: BullNose Quarry Blend ■ Pavers: Andover Collection Smooth Chatham Blend

Page 72 – Pavers: Andover Collection StoneCleft Chatham Blend with Portsmouth Cobble Graphite Inlay ■ Firepit: Roman Pisa Vineyard Blend with Olde Boston Wall Graphite accent course and CastStone Coping Graphite

Page 73 – Steps: Rockport Steps Fieldstone Blend ■ Natural Stone

Page 74 – Steps: Rockport Steps Fieldstone Blend

Page 75 Top – Fire Pit: ScapeStone Fire Pit Quarry Blend with CastStone Coping Slate Grey ■ Pavers: Andover Collection Smooth Oxford Grey

Page 75 Bottom – Steps: Chelmsford Steps Slate Grey ■ Wall: Roman Pisa Vineyard Blend with Universal Coping Quarry Blend

Page 76 Top – Steps: Rockport Step Fieldstone Blend

Page 76 Bottom – Steps: Rockport Pathway Stones Fieldstone Blend

Page 78 Top – Pillar: Roman Pisa Quarry Blend with Carlisle Pillar Cap Graphite ■ Wall: 6" Ancestral WallStone Quarry Blend with CastStone Rockface Coping Graphite

Page 78 Bottom – Steps: Chelmsford Step Slate Grey ■ Wall: 3" & 6" Ancestral WallStone Vineyard Blend with Ancestral Coping Vineyard ■ Granite Cobbles

Page 80 – Pavers: Boston Colonial Quarry Blend and Graphite with Andover 5511 Graphite ■ ScapeStone XL Fire Pit Quarry Blend with CastStone Coping Slate Grey

Page 81 – Fire Pit: Olde Boston Wall Fire Pit Quarry Blend with CastStone Coping Slate Grey ■ Pavers: Andover Collection Smooth Chatham Blend with Andover 5511 Smooth Graphite banding

Page 82 – Fireplace: King Arthur Fireplace with Round Natural Stone Veneer & Black Granite Coping ■ Pavers: Andover Collection Smooth Oxford Blend with Portsmouth Cobble Graphite banding

Page 83 – Fireplace: King Arthur Fireplace with Side Boxes, Natural Stone Veneer and Thermal Bluestone Caps ■ Pavers: Bluestone

Page 84 – Bottom: Fireplace: King Arthur Fireplace with Side Boxes, Natural Stone Veneer and Bluestone Caps ■ Pavers: Bluestone

Page 86 – Pavers: Blue Mist Granite pattern stock

Page 87 Top – Pavers: Andover Collection Smooth Chatham Blend with Andover 5511 Smooth Graphite sailor course ■ Pool: Natural Stone Veneer with Salt & Pepper Granite Coping & Stanstead Granite Steps

Page 87 Bottom – Pavers: Blue Mist granite pattern stock

Page 88 Top – Fireplace: King Arthur Fireplace with Side Boxes, Natural Stone Veneer and Thermal Bluestone Caps

Page 88 Bottom – Steps: Stanstead Granite Rockface Steps ■ Wall: Natural Stone Veneer with Thermal Bluestone Caps

Page 90 – Steps: Rockface Blue Mist Granite ■ Pavers: Blue Mist Granite Pattern Stock ■ Decorative Stone: Mexican Beach Pebble

Page 92 Top – Wall: PA Natural Wallstone ■ Border: Granite Cobblestone

Page 92 Bottom – Steps: Split face Stanstead Granite steps ■ Wall: Mixed Connecticut Tan and Connecticut Gray Wallstone with Salt & Pepper Granite cap ■ Pavers: Thermal Bluestone pattern

PROFESSIONALLY INSTALLED OR DO-IT-YOURSELF? WE CAN HELP



Deciding often depends on the size and scope of the work, as well as how ambitious you are. While small walks may be a weekend project, others will take far longer. Your Ideal dealer can suggest contractors suited for your project. Be sure to check references, visit projects they have installed, make sure they have insurance and...get it in writing!!

Visit our website www.IdealBlock.com for more helpful tips on hiring a contractor. For the ambitious DIY-er we have easy-to-follow instructions that will guide you step-by-step for beautiful results. Ask your Ideal Authorized Dealer for one of our paver or wall installation booklets or download them from our website.

TRADITIONAL PAVER INSTALLATION

- Excavate and thoroughly compact area to be paved.
- Install and compact base in 2-4" layers (1 1/2" processed gravel or 3/4" minus crusher run).
 - Typically 4-6" deep for walkways and patios
 - Typically 6-8" deep for pool decks
 - Typically 8-12" deep for driveways
 - See your Dealer for more information
- Install edge restraints directly on the base and secure with 10" steel spikes.
- Spread coarse concrete sand as a setting bed and screed to a uniform depth of 1" thick.
- Starting from a 90° corner, place pavers in desired pattern and cut where necessary to fit. Use 2 3/8" thick pavers for most residential applications and 3 1/8" thick pavers for commercial vehicles.
- Compact the pavers into the sand bed with a plate compactor or rubber mallet.
- Sweep dry sand into joints and compact. Repeat procedure until the joints are full. If using polymeric sand follow manufacturer's directions.

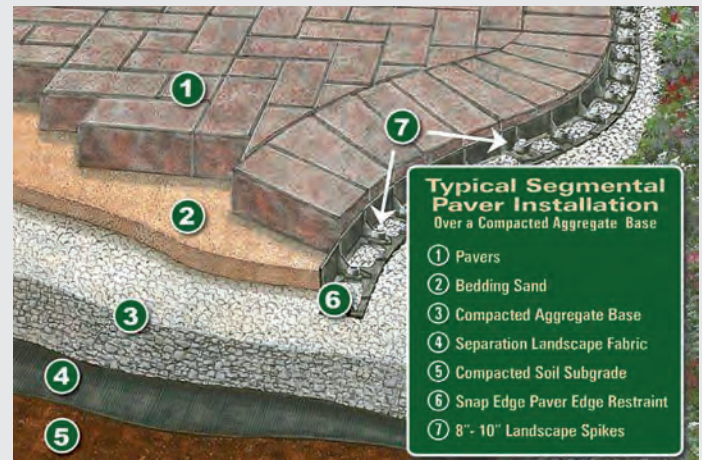

Note: Poor draining soils, such as clay, may require additional excavation and base material and the use of a woven geotextile fabric.

PERMEABLE PAVER INSTALLATION

While similar to traditional pavers, this installation method contains a few important differences.

- Processed gravel can be used as a base, but we recommend open-graded stone, preferably 1 1/2" open-graded crushed stone, for peak performance.
- Deeper excavation is required.
 - Typically at least 6-8" for walkways and patios
 - Typically a minimum of 8-12" for driveways
- The setting bed increases to 2".
- 3/8" crushed stone is used for the setting bed.
- 1/4" chip stone is used to fill the joints and openings.
- Edge restraint requires the use of the Berm Method, CurbStone Edging or SEK PermEdge.

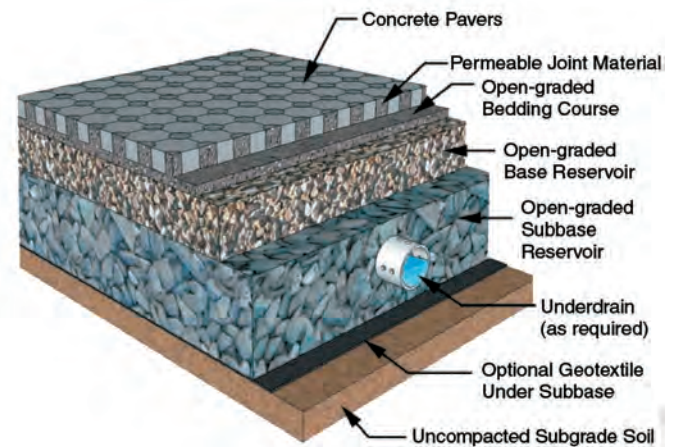

RETAINING WALL INSTALLATION

- Excavate a trench about 12" deep by 24" wide for the length of the wall.
- Compact the subgrade soil thoroughly and line the excavated area with landscape fabric.
- Fill the trench with 1 1/2" processed gravel or 3/4" crusher run base material and firmly compact in 2-3" layers until base is 6" thick.
- Place and level the first course of wall units on the base.
- Place perforated pipe behind the wall for drainage and backfill with 3/4" crushed stone.
- Place successive courses by stacking wall units on top of the row below, staggering joints as you go.
- Depending on the style wall selected, units will connect and automatically step back with plugs or a tongue and groove.
- Backfill with 3/4" crushed stone behind each course and in each core of the block if applicable and compact.
- Finish the wall by attaching the coping units with professional grade wall block adhesive.

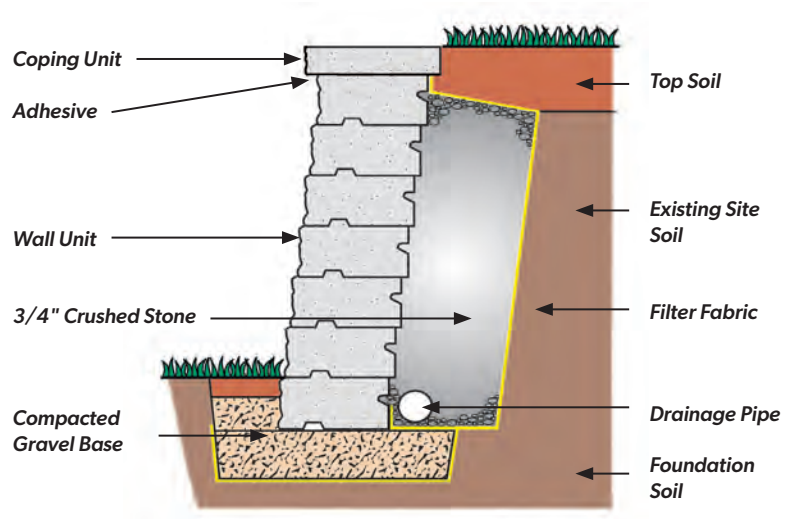

SPECIAL CONSIDERATIONS

Walls 4' and higher, terraced walls, sites with weak or wet soils, slopes and other loading conditions, such as a driveway above the wall, require special consideration. These should be built as reinforced walls using other construction techniques, including the use of geogrid. A civil/soils engineer and a professional contractor should be used for these situations.

GravityStone® retaining walls, pillars, and free-standing walls require different construction methods. Please see our wall guides available at www.IdealBlock.com for more information on installation.

Play it safe and contact your deal Block® Authorized Dealer for more information regarding the above special considerations.

WALL GUIDE CHART

Product	Double-Sided Free Standing	Sitting Wall	Garden Wall <27"	Retaining Wall <48"	Retaining Walls >48" <72"	Retaining Walls >72" <96"	Retaining Walls >96"
Ancestral Wall	A Best Choice	A Best Choice	A Best Choice	Up to 39" *	No	No	No
Olde Boston WallStone	Yes	Yes	A Best Choice	No	No	No	No
Roman Pisa	No	No	Yes	Yes	Yes with Grid	Yes with Grid	Yes with Grid
Fat Face	No	No	Yes	Yes	Yes with Grid	Yes with Grid	Yes with Grid

* Note: Maximum height when battered back & properly designed.

Trademark Information

Andover Collection StoneCleft™, Andover Collection Smooth™, Andover 5511™, Boston Colonial Pavers®, Yankee Cobble™, MillStone™, BrookStone™, Portsmouth Cobble™, CastStone Coping™, CurbStone™, ScapeStone™, ScapeStone XL™, Olde Boston Wall™, Ancestral WallStone & Coping™, Chelmsford Step™, Carlisle Pillar Cap™, RockPort Steps™, Universal Coping™, Color with 4D Technology™, are trademarks of Ideal Concrete Block Co.

Ideal is contracted to produce a number of products under exclusive license agreements

Roman Pisa® is a registered trademark of RisiStone.

Fat Face,® is a registered trademark of Westblock Products, Inc.

Aqua-Bric® and Aqua-Bric 8™ are registered trademarks of Advanced Pavement Technology



QUALITY • SERVICE • RELIABILITY

Ideal...As we celebrate our 100th year, we are proud to introduce a new logo to emphasize the brand we are best known by – IDEAL. A 4th generation family-owned business, we take pride in honoring the Ideal tradition of quality and service, which has been proudly passed to four generations of the Burgoyne family.

A name you can rely on! - We have made New England our home for 100 years and, in 1975, were one of the first companies in the United States to manufacture concrete pavers. We bring you over 45 years of experience and have sold millions of square feet of pavers and countless walls throughout New England! You can feel confident using Ideal. Our products are backed by a Lifetime Warranty and our name. After all, you might say we are time tested...since 1923.

Our commitment to quality – We take great pride in producing the finest concrete products. They are manufactured according to strict industry specifications and benchmarked by our exacting internal standards. Our commitment to excellence ensures superb quality, exceptional strength, lasting durability, and consistent, rich color.

We are here for you - Ideal values our relationship with our customers. We have partnered with an extensive network of Authorized Dealers throughout New England who share our core values to provide responsive customer service and expertise that meets your needs.

*Thank you,
The Burgoyne Family*



www.facebook.com/PaversbyIdeal
www.instagram.com/PaversbyIdeal
www.twitter.com/ByPavers
www.youtube.com/IdealConcreteBlock

www.IdealBlock.com

45-55 Power Road, Westford, MA 01886
232 Lexington Street, Waltham, MA 02452
Phone: 781.894.3200

