



# CONTRACTOR HANDBOOK



**VERSATEX®**  
**BUILDING PRODUCTS**

# TABLE OF CONTENTS

Introduction . . . . .	5
<b>Product Offerings</b>	
Trimboard . . . . .	6
Sheet . . . . .	7
Cornerboard . . . . .	8
T&G Profiles . . . . .	9-10
Canvas Series . . . . .	11
Stealth Trim . . . . .	12-13
Stealth Corners . . . . .	14
Stealth Skirtboards . . . . .	15-16
Soffit System . . . . .	16-17
VERSAWRAP Column Wraps . . . . .	18-21
Mouldings . . . . .	22-25
Crown Profiles . . . . .	22
Cove Profiles . . . . .	23
Additional Profiles . . . . .	23
Sill Profiles . . . . .	24
Casing Profiles . . . . .	25
Finishing System . . . . .	26
<b>Installing VERSATEX</b>	
Cutting . . . . .	27
Routing . . . . .	27
Moulding & Milling (CNC) . . . . .	28-29
Cutting, Routing, & Milling VERSATEX 2X MAX . . . . .	29-30
VERSAWRAP 2X MAX Load Span Charts . . . . .	31
Drilling . . . . .	32
Fastening . . . . .	32-35
Adhesives . . . . .	35-37
Sealants . . . . .	37
Jointing . . . . .	38
Filling Nail Holes . . . . .	38
Painting . . . . .	39-41
Moisture . . . . .	42
Cleaning VERSATEX and Canvas Series . . . . .	42

Storage and Handling .....	43
Safety .....	43
Expansion & Contraction .....	44-46
ASTM Chart .....	47
Stealth Trim Installation .....	48-51
Stealth Corner Installation .....	52-53
Stealth Skirtboard Installation .....	54-55
Water Table Starter .....	56
Band Board Installation .....	57
VERSATEX Traditional Window Casing .....	58
Inside Corner Installations .....	59
Garage Door Seal Installation .....	60
Soffit System Installation .....	61-65
Ceiling with Beadboard .....	66-68
Wainscoting Detail .....	69
Canvas Series Installation .....	70-71
VERSAWRAP Classic & Raised Panel .....	72-74
VERSAWRAP for Railings .....	75-76
VERSAWRAP Tapered .....	77-78
Pergola Beam Fabrication .....	79
Moulding Installation .....	80
Brick Mould Installation .....	81
Drip Cap Rake and Sub Sill Moulding Application .....	82
Sill and Brick Mould Window Application .....	83
Frequently Asked Questions .....	84-93
Other Construction Documents .....	95
Notes .....	96-99

This handbook is designed to answer questions and provide detailed guidance for builders and contractors working with VERSATEX cellular PVC.



It has been developed in large part through discussions with installers who have a working knowledge of PVC trim and have been willing to share best practices in a variety of areas. This guide will introduce you to all VERSATEX products, thus ensuring you are ordering exactly what you need for your job. It will also provide both generic installation information and detailed accounts of specific construction practices.

*Our goal at VERSATEX is to provide you with the best possible installation information available so that your experience with our products is a favorable one. Should you require additional information that is not found in this document, please feel free to contact our engineering department directly at 724.857.1111 or look us up online at [www.versatex.com](http://www.versatex.com).*

## DO YOUR HOMEWORK

When selecting your cellular PVC trim for a remodel or new construction project, be sure to do your homework, carefully reviewing the features, benefits and physical properties of the product. For example:

- What's the manufacturer's warranty? Is it transferrable?
- What is the flame spread rating class? "A" or "B"?
- What is the density of the trim?
- Are the 5/4 boards 1" or 15/16"?
- How about the thickness tolerance? When two boards are butted together, do you end up with a step between them?
- Does the board look grey or white? Grey boards might be a sign the product is loaded with filler (limestone). This along with reductions in key components could have an adverse effect on the physical properties and life of the trim you're purchasing for a homeowner or GC.

Once you've done your research you'll discover **not all PVC trims are created equal**, and that VERSATEX delivers high-quality PVC trim and innovations that help you **Trim Smarter**.

# I. PRODUCT OFFERINGS

## TRIMBOARD



NOMINAL SIZES	WIDTH								
Thickness	2	3	4	5	6	8	10	12	16
5/8 (5/8" Actual)			■		■	■	■	■	■
1 (3/4" Actual)	■	■	■	■	■	■	■	■	■
5/4 (1" Actual)			■	■	■	■	■	■	■
6/4 (1 1/4" Actual)			■		■	■	■	■	
8/4 (1 1/2" Actual)			■		■	■	■	■	

- Available in standard 12' and 18' lengths
- Custom lengths and widths available in "Smartpack" quantities
- Most thicknesses can be ordered reversible -  
Smooth/Timber Ridge or Smooth/Smooth

## SHEET



ACTUAL SIZES	WIDTH AND LENGTH				
Thickness	4x8'	4x10'	4x12'	4x18'	4x20'
1/4"	■	■			
3/8"	■	■	■	■	
1/2"	■	■	■	■	■
5/8"	■	■	■	■	
3/4"	■	■	■	■	■
1"	■	■	■	■	■
1 1/4"	■	■	■	■	
1 1/2"	■	■	■	■	

- Custom lengths and width available in "Smartpack" quantities
- 5' wide Sheets available in 1/2" and 3/4" thicknesses (minimum order quantity and extended lead time)
- Beaded Sheets available on page 9
- Most thicknesses can be ordered reversible -  
Smooth/Timber Ridge or Smooth/Smooth

## CORNERBOARDS



NOMINAL SIZES	LENGTH AND FINISH				
	Smooth			Timber Ridge	
Thickness	10'	20'	22'	10'	20'
1 x 6		■			
5/4 x 4	■	■	■	■	■
5/4 x 6	■	■	■	■	■
5/4 x 8		■			

- Special 12' and 22' Corners available in "UNIT" quantities
- Custom Corner widths up to 10" available in "UNIT" quantities
- Stealth Corners also available on page 14

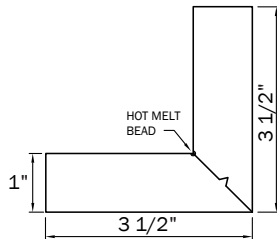

Regular Corner | Nominal 5/4 x 4 Profile

## T&G PROFILES



NOMINAL SIZES	ACTUAL SIZE	LENGTH		
		8'	10'	18'
Thickness				
1/2 x 4 (Regular Beadboard)	1/2" x 3 1/2"			■
1/2 x 6 (Regular Beadboard)	1/2" x 5 1/2"			■
1 x 6 (Regular Beadboard)	3/4" x 5 1/2"			■
1/2 x 4 (Stealth Beadboard)	1/2" x 4"			■
1/2 x 6 (Stealth Beadboard)	1/2" x 6"			■
1/2 x 6 (Piazza Blue Beadboard)	1/2" x 6"			■
1/2" x 4' (Beaded Sheet)	1/2" x 4'	■	■	
1 x 6 (WP4/Nickel Gap)	3/4" x 5 1/2"			■
1 x 6 (Shiplap)	3/4" x 5 1/2"			■
1 x 8 (Shiplap)	3/4" x 7 1/4"			■

- Special 1 x 4 x 18' and 1 x 6 x 18' Regular Beadboard and 1 x 4 x 18' Stealth Beadboard available in "UNIT" quantities
- End-Matched WP4 available in 16' lengths

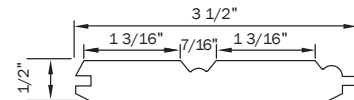

Regular Beadboard | Nominal 1/2 x 4 Profile

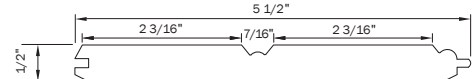

Regular Beadboard | Nominal 1/2 x 6 Profile

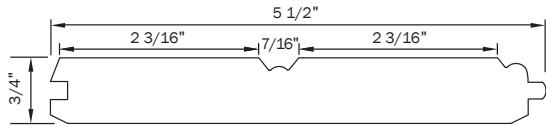

Regular Beadboard | Nominal 1 x 6 Profile

Full CADs and  
Beaded Sheet  
drawing available  
on [versatex.com](http://versatex.com)

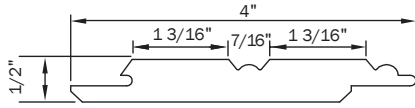

Stealth Beadboard | Nominal 1/2 x 4 Profile

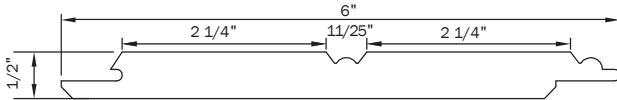

Stealth Beadboard | Nominal 1/2 x 6 Profile

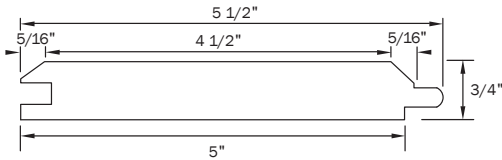

Reversible WP4/Nickel Gap | Nominal 1 x 6 Profile

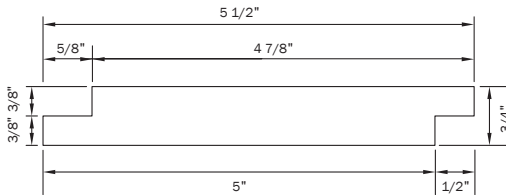

Shiplap | Nominal 1 x 6 Profile

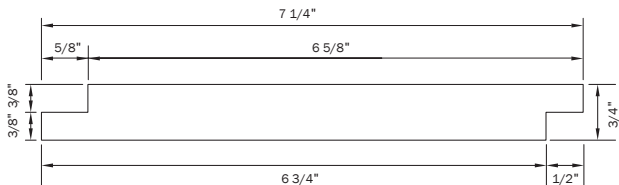

Shiplap | Nominal 1 x 8 Profile

# VERSATEX® *Canvas Series*



NOMINAL SIZES Profiles	ACTUAL SIZE	LENGTH	
		16'	18'
WP4 Tongue & Groove	3/4" x 5 1/2"	■	
Stealth Beadboard	1/2" x 6"	■	
4" Crown	9/16" x 3 5/8"	■	
Bed Mould	9/16" x 1 3/4"	■	

- All profiles available in Black Cherry, Macore, Walnut, Amber, Weathered Grey, Kitami & Turner Oak.
- Color-matched touch-up kit and included with each order (discuss requirements with your dealer)
- Refer to pages 70 - 71 for handling and installation

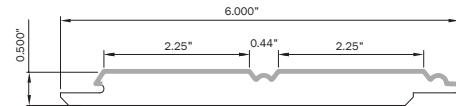

Stealth Beadboard

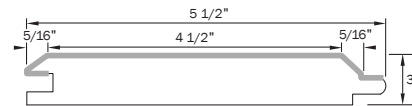

Canvas Series WP4  
Nominal 1 x 6 Profile

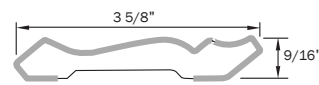

Canvas Series 4" Crown  
Nominal 4 Profile



Bed Mould

Gray lines represent wood laminate coverage on profiles

# Stealth **VERSATEX**<sup>®</sup> TRIM SYSTEM

## STEALTH TRIM



STEALTH TRIM	LENGTH AND FINISH	
	Smooth	Timber Ridge
<b>Nominal Sizes</b>	<b>18'</b>	<b>18'</b>
5/4 x 4	■	■
5/4 x 6	■	■
5/4 x 8 (Standard Stealth Only)	■	■

- Nominal 4 and 6 available in Standard Stealth, Stealth with Flange Slot and Trim with Flange Slot (See drawings on next page.)
- Stealth Casing with J-Channel available in nominal 5/4 x 4 and 5/4 x 6 with Smooth finish
- Stealth Casing with J-Channel not available in custom lengths or widths.
- Custom lengths and widths available in special quantities for profiles.

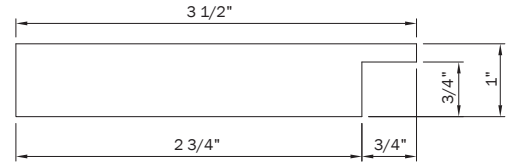

Standard Stealth Trim | Nominal 5/4 x 4 Profile

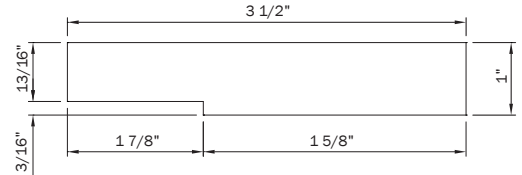

Trim with Flange Slot | Nominal 5/4 x 4 Profile

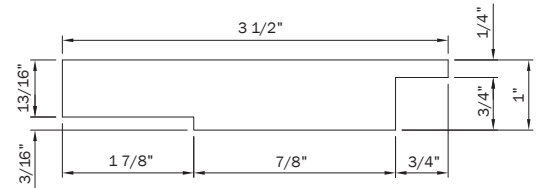

Stealth Trim with Flange Slot | Nominal 5/4 x 4 Profile

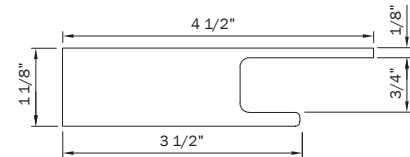

Stealth Casing with J-Channel | Nominal 5/4 x 4 Profile

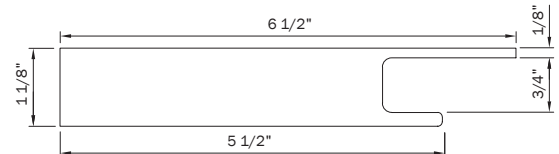

Stealth Casing with J-Channel | Nominal 5/4 x 6 Profile

## STEALTH CORNERS

STEALTH CORNERS	LENGTH AND FINISH			
	Smooth		Timber Ridge	
Nominal Sizes	10'	20'	10'	20'
5/4 x 4	■	■	■	■
5/4 x 6	■	■	■	■
5/4 x 8		■		

- Special 12' and 22' Corners available in "UNIT" quantities
- Custom Corner widths up to nominal 10 available in "UNIT" quantities
- 10' and 20' Corners available in "Smartpack" quantities

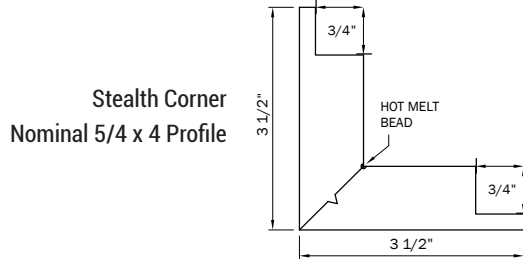

STEALTH HIDDEN FASTENER CORNER	LENGTH AND FINISH	
	Smooth	
Actual Sizes	20'	
1 1/8" x 3 1/2"	outside	■
1 1/8" x 5 1/2"	outside	■
1 1/8" x 1 1/2"	inside	■

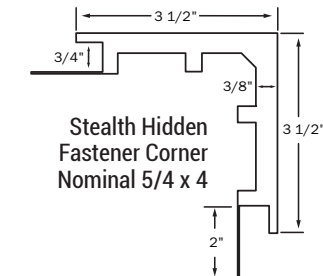
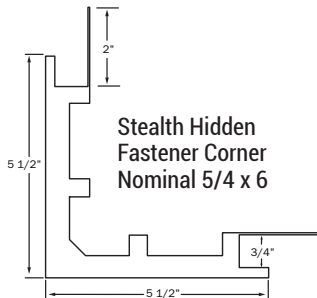

14

## STEALTH SKIRTBOARD



STEALTH SKIRTBOARD	LENGTH AND FINISH	
	Smooth	Timber Ridge
Nominal Sizes	18'	18'
1 x 8	■	■
1 x 10	■	■
5/4 x 6	■	■
5/4 x 8	■	■

- Custom lengths and widths available in special quantities

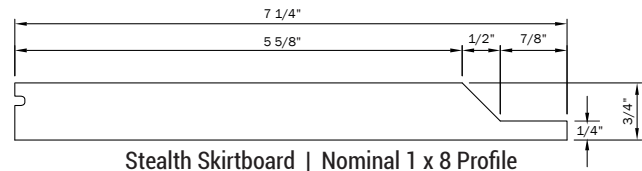
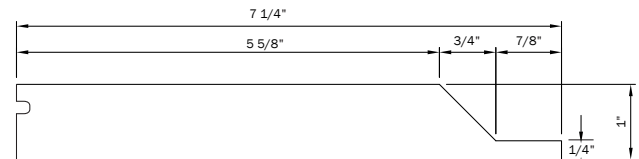

15



## SKIRT & BANDBOARD WITH RIGID PVC STARTER STRIP

Available by special order

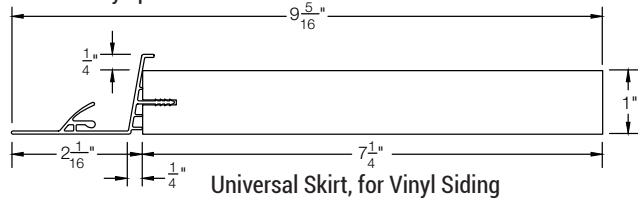

Universal Skirt, for Vinyl Siding

Perfect starter for wood, wood composite, fiber cement and vinyl siding

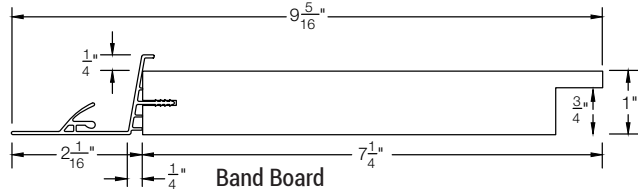

Band Board

Full CADs available on [versatex.com](http://versatex.com)

## SOFFIT SYSTEM



SOFFIT	LENGTH AND TYPE	
	Vented	Solid
<b>Actual Sizes</b>	<b>18'</b>	<b>18'</b>
1/2" x 12"	■	■
1/2" x 16"	■	■
1/2" x 24"	■	■

- Custom lengths available in "Smartpack" quantities
- Available in Smooth only
- 10 square inches of free air space per lineal foot of Vented Soffit
- 5 1/2" dimension on backside of vents allows you to customize the width of the soffit or add mouldings

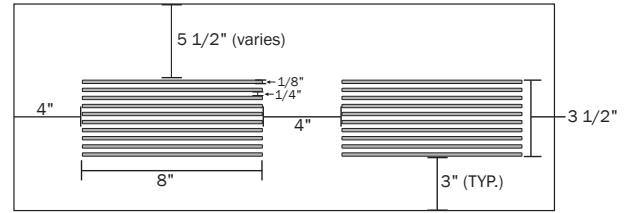

Vented Soffit | Actual 1/2" x 12" Profile

FASCIA	LENGTH AND FINISH	
	Smooth	Timber Ridge
<b>Nominal Sizes</b>	<b>18'</b>	<b>18'</b>
1 x 8	■	■

- Custom lengths and widths available in "Smartpack" quantities
- Pocket accepts any soffits up to 1/2" thick

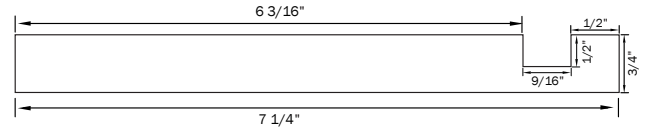

Fascia | Nominal 1 x 8 Profile

FRIEZE	LENGTH AND FINISH	
	Smooth	Timber Ridge
<b>Nominal Sizes</b>	<b>18'</b>	<b>18'</b>
5/4 x 6	■	■

- Custom lengths and widths available in "Smartpack" quantities
- Pocket accepts any soffits up to 1/2" thick

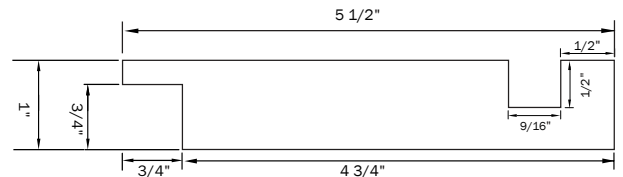

Frieze | Nominal 5/4 x 6 Profile

## VERSAWRAP™ CLASSIC COLUMN WRAPS



VERSAWRAP Classic	INSIDE DIM.	LENGTH		
Nominal Sizes		8' 6"	10'	12'
1/2 x 4 x 4	3 3/4" x 3 3/4"	■	■	
1/2 x 6 x 6	5 3/4" x 5 3/4"	■	■	
1/2 x 8 x 8	8 1/2" x 8 1/2"	■	■	
1 x 12 x 12	9 3/4" x 9 3/4"			■

- Pre-cut, mitered Moulding Kits with Hoffman Dovetail Connectors sold separately
- No accent wraps or Moulding Kits available for nominal 12 wrap
- Custom nominal 10 wraps available in "UNIT" quantities, 4 "UNIT" minimum
- Timber Ridge wraps available through special order
- Nominal 4, 6, and 8 wraps made from actual 1/2" thick VERSATEX; Add 1" to inside dimensions to calculate outside measurements. Nominal 1X12 wraps are an actual 3/4" thick.

### VERSAWRAP Classic & Raised Panel Column Wraps

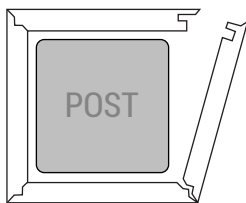

18

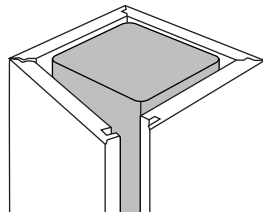

## VERSAWRAP™ RAISED PANEL COLUMN WRAPS

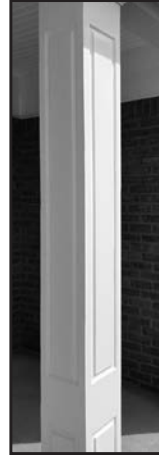

VERSAWRAP Raised Panel	INSIDE DIM.	LENGTH	
Nominal Sizes		8' 6"	10'
1/2 x 6 x 6	5 3/4" x 5 3/4"	■	■
1/2 x 8 x 8	8 1/2" x 8 1/2"	■	■

- For best aesthetic results, painting is recommended to prevent dirt accumulation where panel is milled into product.
- Raised panels start 16 1/2" from bottom with railing gap from 30 3/4" to 38 1/2". Clearance above the top panel measures 8 3/4".

## VERSAWRAP™ POST CAPS

### VERSAWRAP Post Cap

#### Actual Inside Dimension

4 3/4" x 4 3/4"

6 3/4" x 6 3/4"

- Not compatible with Tapered wraps

Post Cap

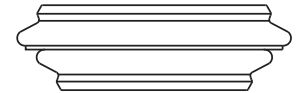

## VERSAWRAP™ ACCENT WRAPS

ACCENT WRAP	INSIDE DIM.	LENGTH	
Nominal Sizes		10"	10'
1/2 x 4 x 4	4 3/4" x 4 3/4"	■	■
1/2 x 6 x 6	6 3/4" x 6 3/4"	■	
1/2 x 8 x 8	9 1/2" x 9 1/2"	■	

- Not compatible with Tapered wraps

19

## VERSAWRAP™ MOULDING KITS

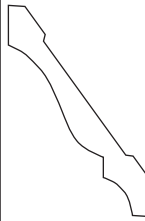

Crown Mould



Base Cap



Bed Mould

### VERSAWRAP Moulding Kits

#### For Nominal 4, 6, & 8 Wraps

Base Cap

Bed Mould

Bed Mould XL

Crown Mould

Crown Mould XL

- All Moulding Kits are pre-cut to length, mitered, and sold in bags with Hoffman Dovetail Connectors for easy assembly and designed to fit snugly around outside dimension of Nominal 4, 6, or 8 Classic and Raised Panel wraps.
- XL Bed Moulding and XL Crown Moulding Kits are cut longer to fit around outside dimension of Accent Wraps.
- All Crown Moulding Kits are made with 4" Crown Mould profile.

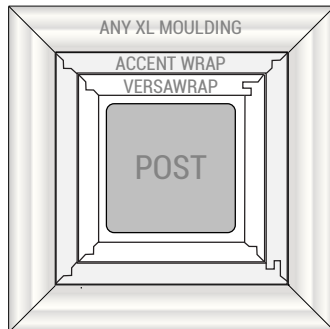

Accent Wrap Application

## VERSAWRAP™ TAPERED COLUMN WRAPS



### VERSAWRAP Tapered

### LENGTH

#### Actual Sizes

5'

6'

12" base / 8" cap



16" base / 12" cap



- Each Tapered Wrap includes 4 column wrap panels, fastening angles, and optional accent wrap piece

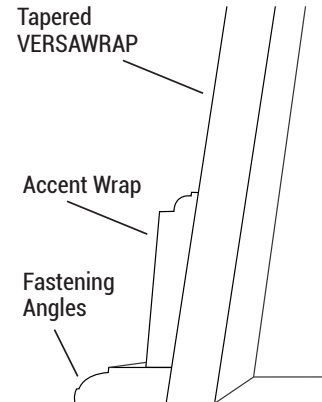

## MOULDINGS

All moulding profiles come in 16' lengths except where noted.

### CROWN PROFILES

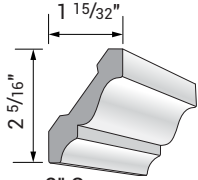

**3" Crown**  
VER52

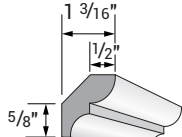

**Bed Mould**  
VER75

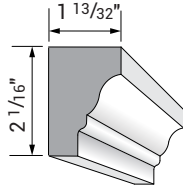

**Rams Crown**  
VERRC01

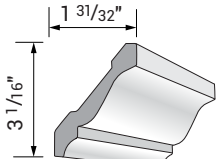

**4" Crown**  
VER49

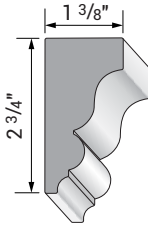

**Imperial Rake**  
VERIR01

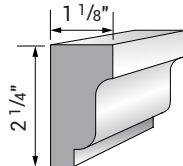

**Solid Crown**  
VER212

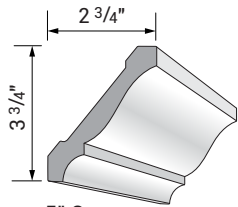

**5" Crown**  
VER47

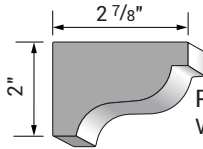

**Pediment Crown**  
VERPC01 ■ 12'

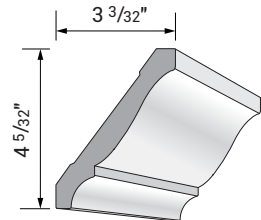

**6" Crown**  
VER45

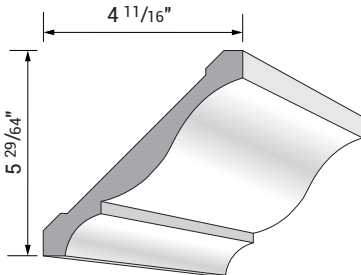

**8" Crown**  
PA8CROWN

## COVE PROFILES

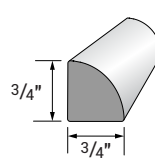

**Quarter Round**  
VER105

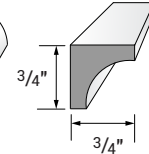

**Scotia Cove**  
VER93

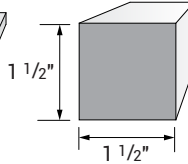

**Baluster**  
VER236

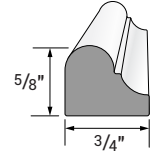

**Nose Cove**  
VERNCO1

### ADDITIONAL PROFILES

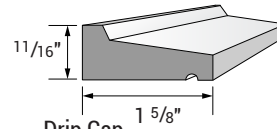

**Drip Cap**  
VER197

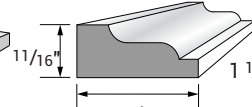

**Shingle Mould**  
VER210

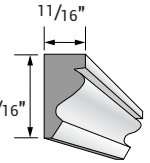

**Panel Mould**  
VER217

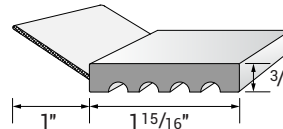

**Garage Seal**  
VERGD01

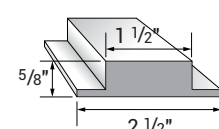

**T-Mould**  
VERT01 ■ 12'

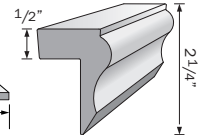

**Beadboard Cap**  
PABEADCAP

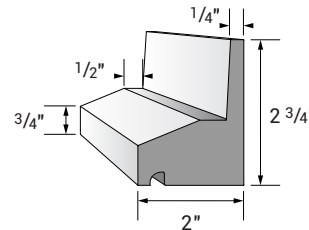

**Water Table**  
VERWT01 ■ 18'

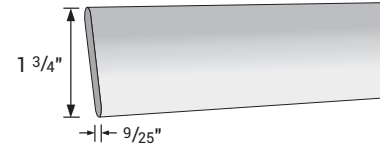

**Louver Blades**

## SILL PROFILES

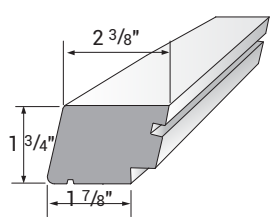
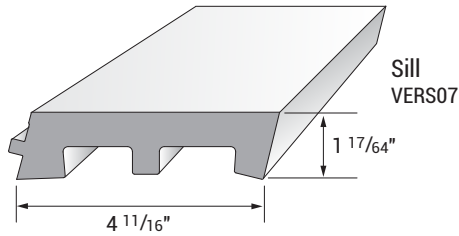

**Heavy Sill Nose  
VERHS01**

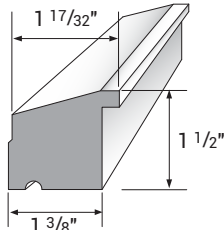

**Sub Sill Nose  
VER282**

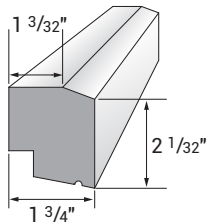

**Historic Sill  
VERHS02**

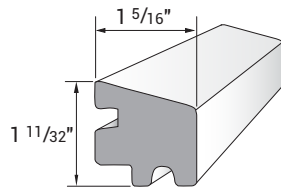

**Sill Nose  
VERSN01**

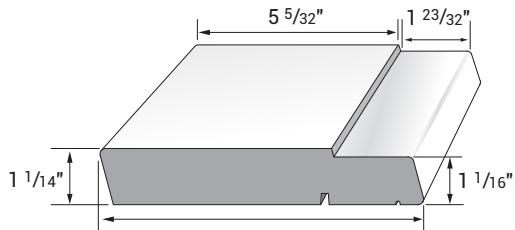

**Double Hung Sill  
VERDHS • 18' • Moulded profile**

## CASING PROFILES

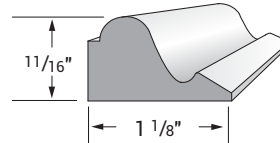

**Base Cap  
VER164**

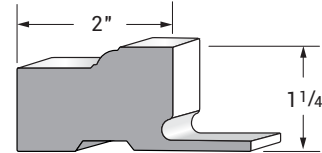

**Brick w/ Flange  
VERBMF01 • 12'**

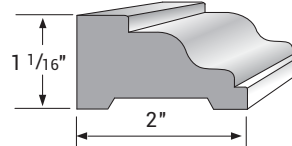

**Rake Moulding  
VER287**

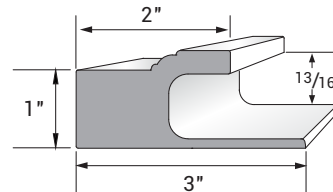

**J-Channel Brick  
VERJB01 • 18'**

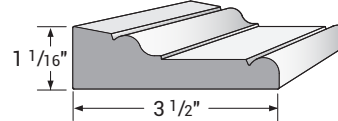

**Adams Casing  
VER97**

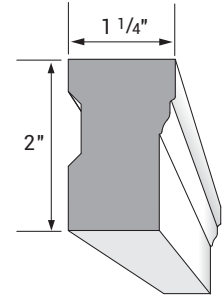

**Brick Mould  
VER180 • 18'**

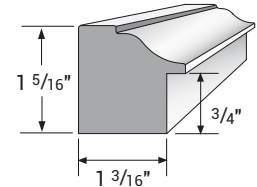

**Backband  
VER281**

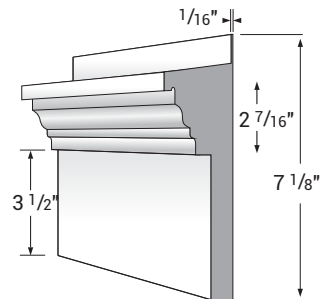

**Crosshead Pediment  
VERCHP01**

### WELD-ON 705

	4oz	5oz	8oz	16oz	32oz	128oz
White				■	■	■
Clear	■		■			
White Squeeze Tube		■				



### #20 BISCUITS

Sold in boxes of 25; Cases include ten boxes



## II. INSTALLING VERSATEX

Installing VERSATEX requires the same tools and fasteners as wood and engineered wood trims.

### CUTTING

- Carbide-tipped blades with fewer teeth are preferred (32 tooth blade optimal).
- Rough cut edges are typically caused by excessive friction, poor board support, or worn/improper tooling.
- Rake angle: 0-5°; cleavage angle: 10-20°.

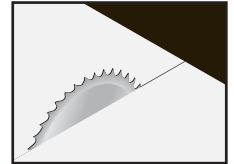

**Note:** The use of fine tooth band saw blades could fuse boards together at cut line. (For more information, see Technical Bulletin C-1 available in the Technical Help section of [versatex.com](http://versatex.com)).

### ROUTING

- Standard wood working carbide-tipped bits with multiple flutes are recommended.
- Maintain sharp tooling. Worn tooling or tooling with chips can lead to softening or gumming of the core due to heat build-up.
- Secure VERSATEX to a fixed object before routing to minimize chatter.

Tip: Sand with 320 grit sand paper and wipe down cuts with solvent to clean and "reseat" cells to reduce dust and dirt build-up.

Tip: When creating 90° corners, use tooling that creates a small radius to prevent stress cracking.

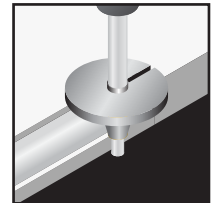

Tip: Spray router and yourself with Static Guard to keep dust off you and your equipment. This applies to any cutting or drilling equipment. (For more information, see Technical Bulletin C-1 on [versatex.com](http://versatex.com)).

## MOULDING & MILLING (CNC)

### For moulding:

- Standard wood working machinery with speeds of 6,000 RPMs or greater (the higher the RPMs, the smoother the cut). Find the "sweet spot" for your machine.
- Feed rates of 20-50 FPM depending on complexity of profile and material thickness.
- Be sure tooling inserts on moulder are properly aligned to provide the best possible cut – Concentric Alignment.
- Hook angle ( $12^{\circ}$  –  $15^{\circ}$ ) – Angle of cutter as it sits in the cutterhead. Steeper angles lessen tear out and reduces the amount of fines and chips between cutter and VERSATEX board.
- Relief Angle ( $15^{\circ}$  –  $20^{\circ}$ ) – Angle at which end of blade is ground.

Tip: Sharp tooling made of carbide or high speed steel, hold down clamps and optimum dust collection will produce a premium finish.

### For milling:

- Carbide tooling is recommended.
- Use a single edge up cut spiral bit at a chip load of 0.016" to 0.018". Keep your tooling sharp and free of any nicks or chips.
- Run tools at 18,000 RPMs and feed speeds between 250-360 in/min (20 to 25 FPM).
- Minimize board movement or vibration – smoother surface finish (less chatter).
- Optimum dust collection

### Tip for multi-layer moulding & milling

If you're interested in gluing sheets or boards of cellular PVC without clamps or a press, consider Raptor® Composite Finish Nails. Raptor nails are a polymer composite that can be run through moulders, lathes, CNC machines, sanding equipment, or table saws without the fear of



hitting a metal nail or damaging your tooling. The nails are available in 14 ga. and 15 ga. at lengths between 1/2" and 2 1/4". Most nails have a chisel point tip and are available in white to closely match your VERSATEX trimboard. Raptor offers a gun specifically for their nails, OMER B17P.763 finish nailer. Although Raptor recommends their nails for exterior trim applications, we recommend limiting its use to glue ups and other fabrication projects.

## CUTTING, ROUTING, AND MILLING 2X MAX

### Sweet spot of every moulder. The correlation between RPM of cutter head and feed rate of piece into machine

- On 1 1/2" sheet or boards at 12,000 RPM the optimal feed rate is 70 to 80 FPM.
- 8,000 RPM optimal feed rate 30 - 40 FPM.
- 6,000 RPM optimal feed rate 15 - 20 FPM.

### Critical factors in processing 2X Cellular PVC material through a moulder

Hook Angle (angle of the cutter as it sits in the cutter head)  $12^{\circ}$

- Steeper angles lessen tear out by reducing the lift of the cutter that occurs when angle is  $20^{\circ}$  or more.
- Steeper angles allows less fines and chips to be collected between cutter and the material.
- Fines and chips will cause heat build-up, soften core and may lead to tear out.

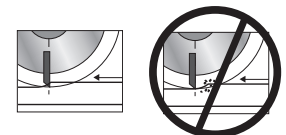
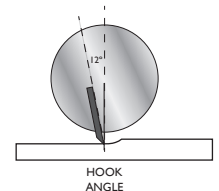

NO CHIPS BETWEEN CUTTER AND SUBSTRATE

### Good Dust Collection

- Must have very good removal of dust and chips to minimize heat build-up on substrate and tooling.

**Cutter Inserts Must be Sharp**

- Dull blades increase heat build-up and will cause tear out.

**Concentricity or Positioning of the Cutters Within the Cutter Head**

- The more concentric the cutters, the smoother and better the cut.
- Concentric alignment of each cutter enables each blade cutter to do work with each revolution.

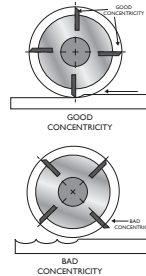

**Using Hog Out Technique (removing material prior to final moulder pass for profile desired)**

- Use when trying to remove too much material in one pass.
- Profile requires deep penetration into the PVC substrate.

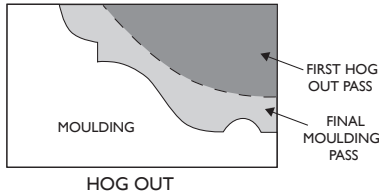

- Extra pass can assure a smoother cut, better surface quality and significantly reduce tear out.

**Ideal Material For Cutter Blades**

- Carbide tooling should be used for longer runs - 3,000 LF or greater.
- M-2 steel for smaller run quantities.
- Other steels will require sharpening every 750 to 1,000 LF.

**Relief Angle of Cutter Blade (angle at which end of blade is ground)**

- OEM's have used 15 to 20 degrees.

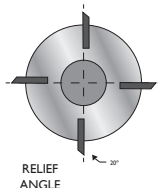

**2X8 Nominal Board Dimension (should only span 8')**

Span	Deflection	Load
10'	0.90"	100 lbs.
12'	1.50"	100 lbs.
16'	3.75"	100 lbs.
18'	4.50"	100 lbs.

**2X10 Nominal Board Dimension**

Span	Deflection	Load
10'	0.30"	100 lbs.
12'	0.50"	100 lbs.
16'	1.50"	100 lbs.
18'	2.00"	100 lbs.

**2X12 Nominal Board Dimension**

Span	Deflection	Load
10'	0.17"	100 lbs.
12'	0.30"	100 lbs.
16'	0.50"	100 lbs.
18'	1.00"	100 lbs.

To request architectural testing data for our 2X boards, please contact us at 724.857.1111 or [sales@versatex.com](mailto:sales@versatex.com).



## DRILLING

- VERSATEX can be drilled using standard woodworking steel twist drill bits.
  - Do not use drill bits made for rigid PVC.
- Periodically remove shavings from drill hole as necessary to avoid frictional heat build-up.
- Point angle: 90-110°; Spiral angle: 30°; Reflect angle: 10°

## FASTENING

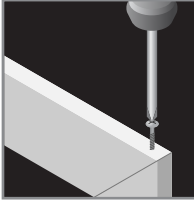
- Use 8d nails designed for wood trim that have thin shanks, blunt points and full round heads with annular threads.
- Use a shorter/thinner gauge fastener such as a 4d finish nail for securing mouldings. Use adhesives on mouldings for additional holding power.
- Fasteners must penetrate a full 1 1/4" into substrate. (stud, joist or solid framing member)
 
- If you can bend a fastener (16 ga. or 18 ga. trim nail) between your fingers, it is too thin.
- Fasten 2" maximum from end of board (3/4" preferred).
- Stainless fasteners are preferred over galvanized to reduce chance of corrosion (galv. stripping off fasteners).
- Set nail guns to PSI between 80-100 depending on gun, nail, outside temperature, and substrate.
- Use 7d trim screws for optimum hold strength.
- In temps under 40°F, pre-drilling may be required. Consider using screws at low temperatures.
- To achieve necessary holding power, avoid brads, staples, ring shank nails, or fine threaded wood screws on all trimboards.

- 1/2" Stealth Beadboard should be fastened with 1/4" wide X 1" deep galvanized or stainless steel staples.
- 3/8" and 1/2" sheet product is not intended to be ripped into trim pieces. These thicknesses must be glued to a substrate and mechanically fastened.

## FASTENING SCHEDULE

Nominal Board Width	Fasteners per width a maximum of every 16" on center
3	1
4 & 6	2
8 & 10	3
12	3-4
16	4-5

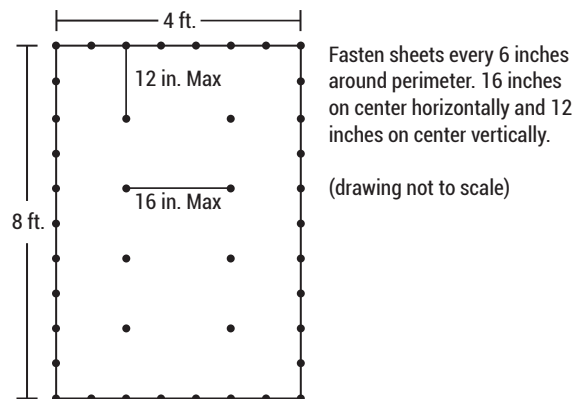

## RECOMMENDED FASTENER SCREWS

Starborn Stainless Steel Headcote Screw



Simpson Strong-Tie PVC Trim-Board Screw  
Can be set flush with trim



Also recommended: GRK Fasteners #8 X 2 1/4" RT Composite Stainless Steel Trim Head Screw with White Head

**FastenMaster Cortex Fastening System Screw Plug System with VERSATEX Plugs**



*NOTE: 2 3/4" Screws are available for VERSATEX 2X MAX and 2" lengths are available for 5/8" through 5/4". Special fasteners are available for steel framing. Matching plugs also available for Canvas Series finishes.*

*NOTE: Use the same number of Cortex or Starborn screws as you do nails.*

**Starborn Pro Plug System with VERSATEX Plugs**



*Available in 2" to 3" Epoxy coated carbon steel or 305/316 stainless steel screws. System includes patented PVC/composite chuck to properly set screw depth.*

**RECOMMENDED FASTENER NAIL SYSTEMS**

**RAPTOR Composite Finish Nails and Nailer**



*RAPTOR nails are a polymer composite that can be run through moulders, lathes, CNC machines, sanding equipment or table saws without the fear of hitting a metal nail or damaging your tooling. The OMER B17P.763 finish nailer is the premium and most versatile tool in the product line.*

**Aerosmith Fastening System and Trim Pins**

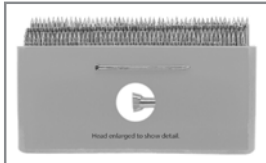

*A "finish nail" like head and a wide range of pin lengths means an aesthetically pleasing job for fastening on block wall trim installs or other hard surfaces.*

**RECOMMENDED FASTENER NAILS**

8d Nails with Annular threads (ex. Simpson Strong-Tie PVC Trim-Board Nail). The PVC Trim-Board Nail is available collated for use with a variety of nail guns.



**ADHESIVES**

- PVC Adhesives: Weld-On 705, Christy's Red Hot White, Extreme Adhesives TrimWelder White Hot
- Methacrylates with UV Inhibitors (2 components): PVC TrimWelder by Extreme Adhesives (slow cure, fast cure, or laminating grade), Chem-Set TrimGrip by Chemical Concepts

**ADHESIVE TIPS:**

- Some solvent based cements have a very limited working time, 3 to 5 minutes.
- Adhesives alone are not recommended for securing VERSATEX to a substrate. Mechanical fastening is *always* required.
- Always test unknown adhesives on a scrap piece of VERSATEX before using or call our technical group at 724.857.1111.
- Temperature and humidity may affect adhesive performance.

**RECOMMENDED ADHESIVES**



Weld-On 705



Christy's Red Hot White

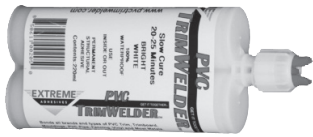

TrimWelder 2-Component  
(slow cure, fast cure or laminating grade)



TrimWelder White Hot



Chem-Set TrimGrip

## BONDING VERSATEX TO WOOD

Liquid Nails Subfloor



Liquid Nails Heavy Duty



Polyurethane based adhesives (PL's or equivalent)



NPC Solar Seal



## BONDING VERSATEX TO CONCRETE OR BLOCK

- \*Must be used in conjunction with mechanical fasteners.
- \*Always test sealants and adhesives for compatibility before applying.

Can also use PVC TrimWelder by Extreme Adhesives

NPC Solar Seal



Buildex Tapcon Self Tapping Concrete Screws



## BONDING VERSATEX TO METAL

PVC TrimWelder two component methacrylate by Extreme Adhesives

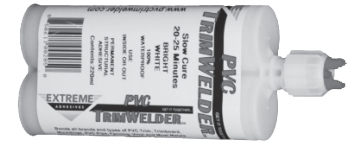

\*Also for bonding VERSATEX to concrete or block.

## SEALANTS

\*Sealants should be polymer-based containing solvents.

**DO NOT  
USE SILICONE.**

NPC Solar Seal; Various urethane sealants



DAP Dynaflex 920



Quad by OSI



PVC Trim Sealant by Titebond



## JOINTING

### VERSATEX #20 Biscuits

- Dimensionally stable
- Precision molded for easy installation.

Enable builders to make tight, permanent joints using standard carpentry techniques and PVC glues.



## FILLING NAIL HOLES

### ONLY Method: (If you don't want to paint)

#### FastenMaster Cortex Fastening System Screw Plug System

with VERSATEX Plugs



#### Starborn Pro Plug System

with VERSATEX Plugs



*Plug systems eliminate need to fill countersunk screw holes.  
For use with board thicknesses between 3/8" and 1"*

## PAINTING

VERSATEX does not require painting for protection. Use paints that are 100% acrylic latex or acrylic latex with urethane additive.

**\*\*CAUTION: PAINTING ANY CELLULAR PVC TRIM, INCLUDING VERSATEX, DARK COLORS WITH A PAINT OTHER THAN AquaSurTech CAN RESULT IN POOR PERFORMANCE AND WILL VOID THE WARRANTY. USE LATEX ACRYLIC PAINTS WHEN THE LIGHT REFLECTIVE VALUE (LRV) IS 50 UNITS OR GREATER.**

When using paints, the liability of performance rests with the paint manufacturer.

### Tips on Painting

- To obtain adequate paint adhesion, be sure the surface of the VERSATEX Trimboard is clean, dry and free of dirt, loose or peeling paint, mildew, chalk, grease and any other surface contaminants before applying paint. Use a mild detergent (Spic 'n Span®) and water or denatured alcohol for cleaning.
- Remove any mold or mildew using a mixture of three parts water, two parts bleach.
- Paint can take up to 30 days to fully cure, depending on outside temperatures, humidity conditions, and other local factors.
- Follow the paint manufacturer's surface preparation and application recommendations.
- Extended paint life is due to the absence of moisture in VERSATEX trim.
- Paint manufacturer may require a primer if the homeowner wants the paint warranty.

## Example of Acceptable and Unacceptable Paint Colors

Pay attention to Light Reflective Values (LRV) when painting VERSATEX with standard paints. Standard paints should have an LRV value of 50 or greater..

### Acceptable Paint Colors:

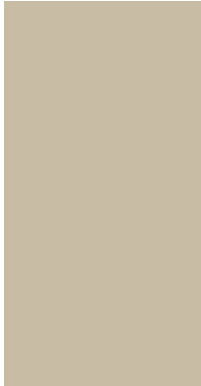

LRV 50

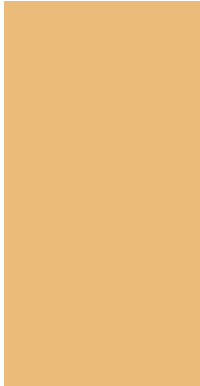

LRV 53

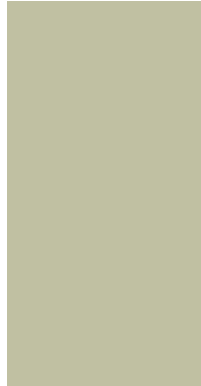

LRV 55

### Unacceptable Paint Colors:

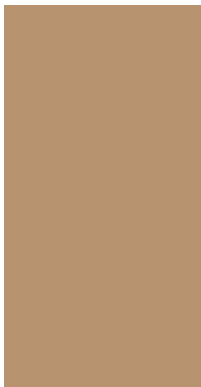

LRV 31

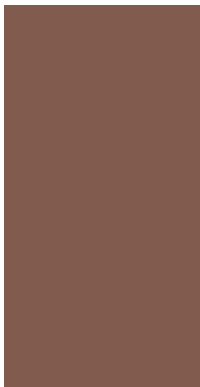

LRV 5

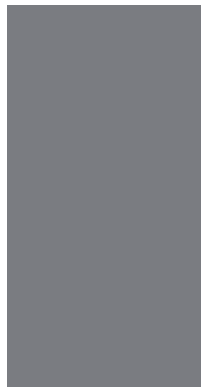

LRV 19

## Option for Dark Colors

AquaSurTech OEM offers "IR heat reflective" paints in applications where the standard paint color has an LRV value less than 50 units. It is also warranted for 15 years when applied to VERSATEX trim. Visit [www.aqua-diy.com/versatex](http://www.aqua-diy.com/versatex) for more information.



## MOISTURE

VERSATEX can be installed at or below grade, as it does not wick moisture. VERSATEX is perfect for moisture-prone applications such as garage door jambs, column wraps, ground contact, masonry contact, concrete forms, hot tub surrounds, and at rooflines.

## CLEANING VERSATEX

- VERSATEX will not support mold and mildew growth. (ASTM G-21-96)
- If products get dirty, clean with products like Soft Scrub® with Bleach, Spic and Span®, Simple Green®, Clorox® Regular Bleach, Clorox® Clean-Up®, Clorox® Outdoor Bleach Cleaner, OxiClean™, or Corte-Clean. Use a nylon brush with cleaner or Mr. Clean® Magic Eraser® for stubborn stains. Use 320 grit sand paper to reduce cell size on cut edges of boards.
- Test any cleaner on an inconspicuous area before use.

## CLEANING CANVAS SERIES

- Wipe material with gentle cleanser like Simple Green cleaner and a soft cloth.
- If marking occurs from board-to-board friction, use COSMOFEN 20 PVC Cleaner available through Weiss U.S.A., Monroe, NC. Tel. 704-282-4496

**WARNING:** DO NOT use abrasive scrub pads like Scotch Brite pads or any solvent like acetone and toluene! They will break down the laminates and dull the surface.

## STORAGE AND HANDLING

- Store VERSATEX on a flat level surface. Cellular PVC is more flexible than wood and may conform to the surface on which it is stored.
- Handle VERSATEX as you would "premium" lumber.
- Keep VERSATEX free of dirt and debris. Clean VERSATEX after installation as described above.
- Do not store or place on asphalt or in areas prone to excessive heat build-up.

## SAFETY

- All machining should be done in a well-ventilated area.
- Safety glasses should be worn whenever you are working with VERSATEX.
- When cutting with any power tool, a dust mask is recommended.

- PVC movement occurs due to temperature fluctuations.
- This movement is restricted to product length.
- The product will not swell or shrink like wood or wood composites experiencing a moisture cycle.
- Expansion and contraction is **ONLY** an issue on longer “runs” (rake, fascia, frieze) comprised of multiple pieces (3 or more) 18’ boards. Use tight joints on doors, windows, and on short runs 1-2 boards.
- The more the product is mechanically fastened or bonded on longer runs, the less likely it is to move.
- Screws provide better holding power than nails.
- As a rule, if you can bend the fastener in your fingers it is too thin (no wire or brad nails). 18 galv. and 16 galv. trim nails are not recommended.
- Southern exposure, or areas where product is in direct sunlight, are more prone to movement. More fasteners should be used in combination with expansion joints.
- All joints in high traffic or visible areas should be glued tight. Expansion/contraction joints should be placed in inconspicuous areas along long runs of trim.
- If possible, install long runs when boards and outside temperature are approximately 55-60°F. If practical, install long runs in the morning when it is still cool out and not in the middle of the afternoon.
- Shiplap joints are the superior option, especially on long runs. They provide more adhesive surface area.

### Method #1: Glue the Joints Secure (High Traffic Areas)

1. Shiplap the boards at the joint, and glue the boards together with Weld-On 705 or another acceptable PVC cement.
2. When possible, apply construction adhesive to back side of boards. Liquid Nails Sub Floor Adhesives or Heavy Duty Construction adhesive works well when attaching a VERSATEX fascia board to a subfascia.
3. Double fasten on both sides of joint (remember: screws work best). Use proper amount of fasteners based on board width.

### Best Method: Shiplap

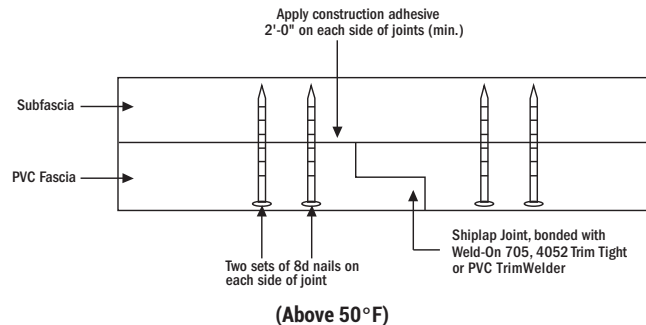

## Method #2: Leaving an Expansion Joint

1. Create a gap between boards. (See sealant manufacturer's recommendation.)
2. Follow proper fastening methods previously outlined.
3. Place UV-resistant acrylic-based or polymer-based sealant in joint between boards (NPC Solar Seal #900 or equal is recommended).
4. Never completely fill joint with sealant. Leave room to compensate for joint closure.

## Best Method: Shiplap Joint

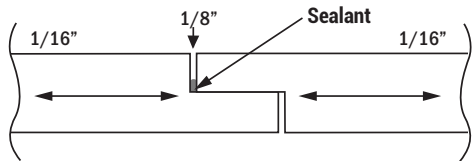

(Below 50°F)

## ASTM CHART

PROPERTY	UNITS	VALUE	ASTM METHOD
<b>Physical</b>			
Density	g/cm <sup>3</sup>	0.55	D 792
Water Absorption	%	<0.50	D 570
<b>Mechanical</b>			
Tensile Strength	psi	3582	D 638
Modulus of Elasticity	psi	209,000	D 638
Flexural Strength of Rupture	psi	5179	D 790
Flexural Modulus of Elasticity	psi	215,000	D 790
Modulus of Elasticity	psi	205,000	D 1037
Elongation	%	9	D 638
Nail Hold	Lbf/in of penetration	300+	D 1761
Staple Hold	Lbf/in of penetration	69	D 1037
Screw Hold	Lbf/in of penetration	240+	D 1037
Gardner Impact	In-lbs	34	D 5420
Notched Izod Impact	Ft-lbs/inch	0.270	D 256
Termite Resistance	--	10	D 3345
Durometer Hardness	Lbf/in	60+	D 2240
Mold Growth		Trace Growth (<10%)	G 21
Compressive Strength	psi	2000-6000 (thickness dependant)	D 695
Uplift Resistance	psf	80	E 330
Parking Garage Ceiling Soffit System	psf	-225 (negative pressure)	UL 580
<b>Thermal</b>			
Coefficient of Linear Expansion	in/in/°F	3.24 x 10 <sup>-5</sup>	D 696
Burning Rate	In/min	Failed to Ignite	D 635
Flame Spread Index	--	Less than 25	E 84
Heat Deflection Temp (264 psi)	°F	146	D 648
Oil Canning (@ 140 °F)	°F	Passed	D 648



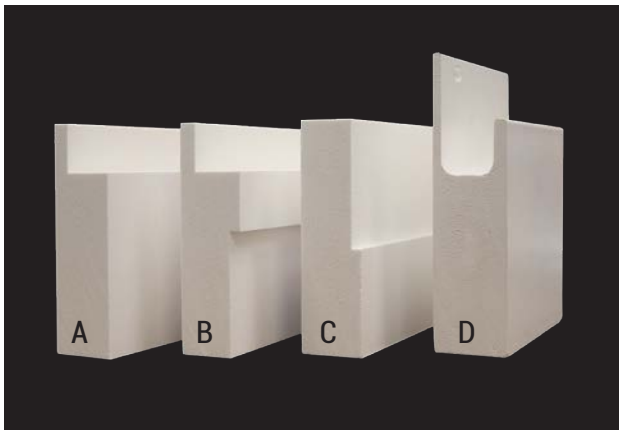

### STEALTH TRIM PROFILES

- A. Standard Stealth Trim
- B. Stealth with Flange Slot
- C. Trim with Flange Slot
- D. Stealth Casing with J-Channel

- Before installing the Stealth Trim, be sure the window area is prepared to accept it. Flash opening in accordance with AAMA method A1 (or local building code requirements).
- Cut the Stealth Trim to create a picture frame. Pocket screw and glue the backside of the Stealth Window Trim pieces to create a Stealth Window Surround.
- We recommend using Historic Sill at the base of the window, Stealth Trim with Flange Slot or Stealth Casing with J-Channel for the jambs, and the Trim with Flange Slot at the header with drip flashing.
- Nail the window surround to wood studs, being sure not to nail through the overhang that conceals your siding. Use stainless steel 8d annular or spiral fasteners designed for wood trim and siding. The fastener must be long enough to penetrate the substrate a minimum of 1 1/4".
- Measure the height and width of the window. Add 1/8" to both dimensions.
- Place fasteners a maximum of 16" on center.
- At the window header, bend a piece of light gage copper or aluminum into an "L" or drip edge and place it on the trim before installing the siding. Vinyl J-Channel at the header is also acceptable when installing vinyl siding.
- Install the siding around the perimeter of the window in accordance with the manufacturer's installation guidelines.

# Stealth Window Surround Installation

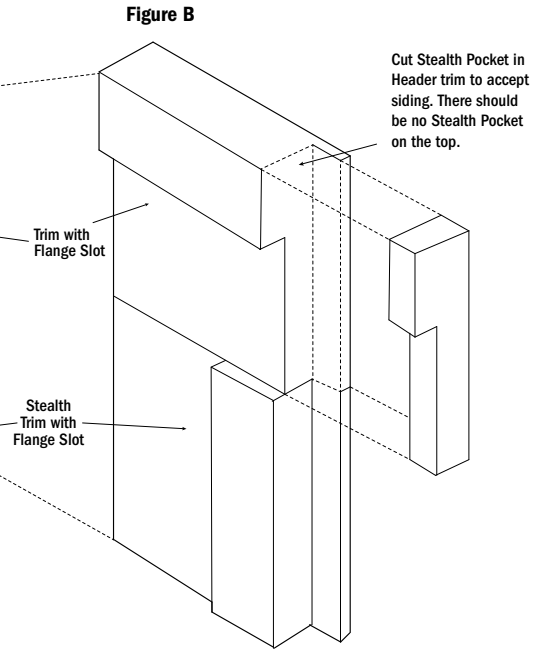
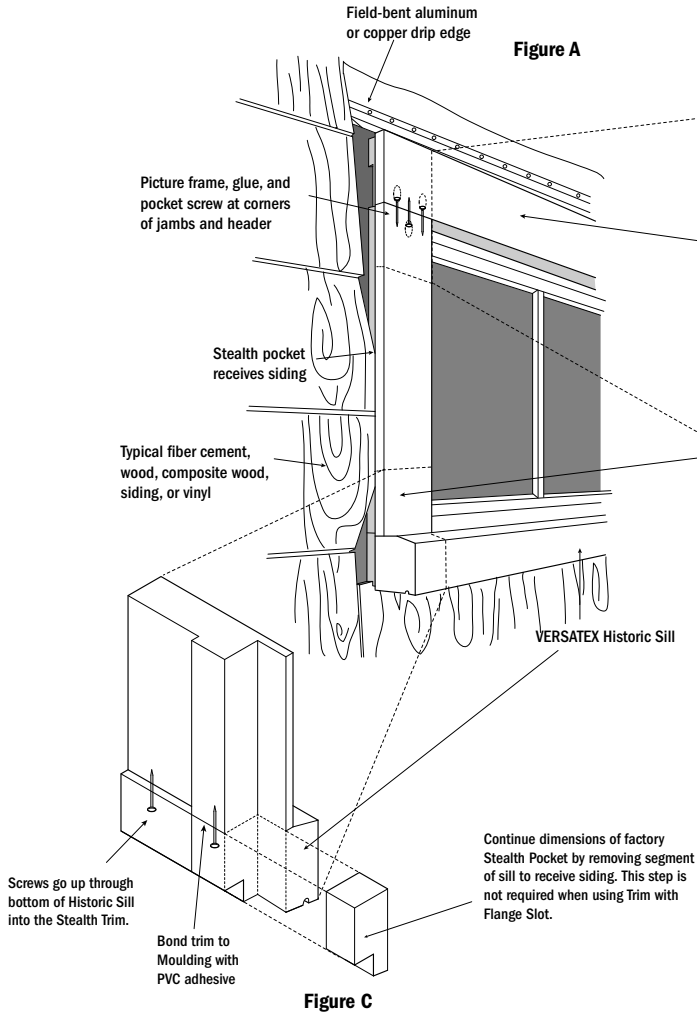

## Stealth Corner Installation Guidelines

- Before installing the Stealth Corner, be sure the corner of the house is prepared to accept it.
- If specified, flash the corner with aluminum trim coil or house wrap in accordance with local building codes. Cover the entire corner, lapping the top piece over the bottom. The flashing should extend 4" to 6" beyond the outside edges of the corner.
- If using fiber cement or a wood composite, caulk or paint the cut ends of siding before installing them.
- Fasten the corner the same way you would fasten a standard VERSATEX Trimboard, being careful not to nail through the overhang that conceals your siding.
- Place the top of the Stealth Corner  $\frac{1}{8}$ " from the underside of the eave. Use stainless steel 8d annular or spiral fasteners designed for wood trim and siding. Screws or a screw and plug system can also be used for securing VERSATEX Corners.
- The fastener must be long enough to penetrate the substrate a minimum of  $1 \frac{1}{4}$ ".
- Place fasteners a maximum of 16" on center.
- Install siding in accordance with manufacturer's recommendations.

## Stealth Corner Application Detail

- \* Flashing is recommended for aesthetics but is not required if house wrap is used.

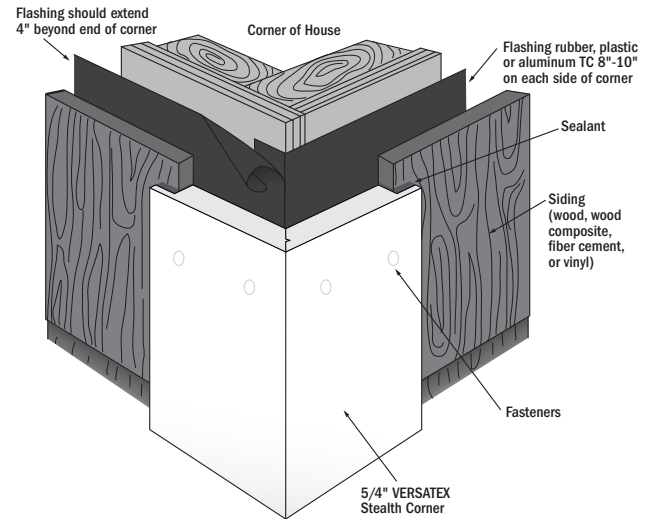

2 fasteners per side on Nominal 4 & 6 corners.  
3 fasteners per side on Nominal 8 and 16 corners.

### Stealth Skirtboard Installation

- Flash around the base of the wall a minimum of 10 1/2" up from the sill plate if house wrap is **not** used.
- Flashing/house wrap should be 1/2" below sill plate.
- Fasten the Stealth Skirtboard the same way you would a VERSATEX Trimboard.
- Since the Skirtboard is so close to grade, stainless steel fasteners (nails or screws) are preferred.
- Maximum fastener spacing 16" on center.
- Install fiber cement, wood, or wood composite siding over the Skirtboard in accordance with the manufacturer's install guidelines leaving a 1/4" gap between bottom of siding and bevel cut on Skirtboard. (See detail on page 55.)

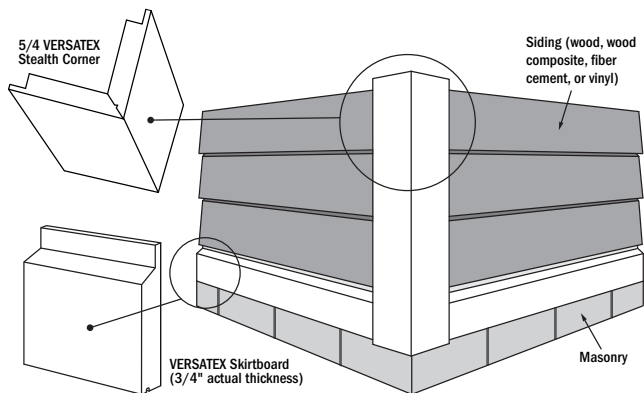

### Stealth Skirtboard Installation at Grade of Fiber Cement or Composite Siding

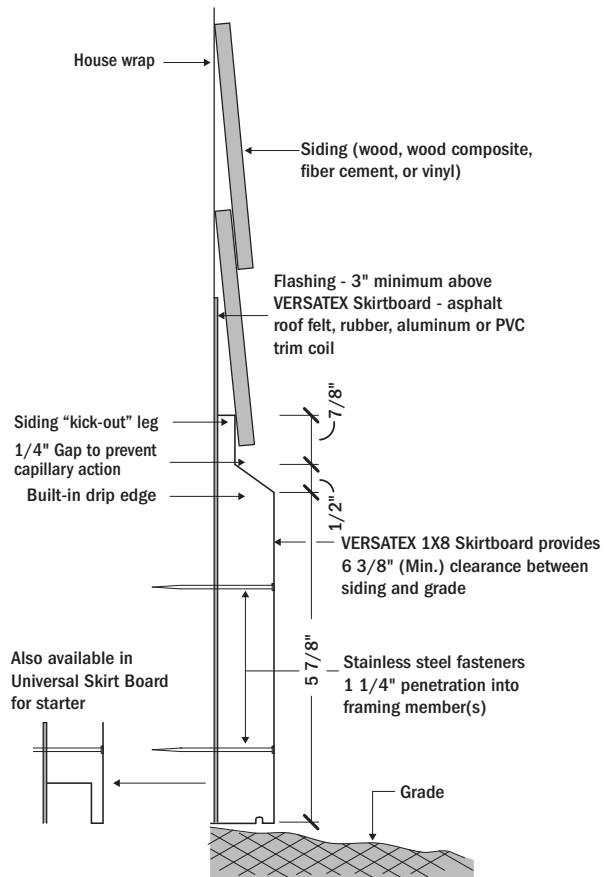

Flashing **not** required if house wrap is used on walls. Housewrap or flashing should extend 1/2" below sill plate. Use 2 fasteners 16" O.C. for nominal 6 skirtboard and 3 fasteners 16" O.C. for nominal 18 skirtboard.

## Water Table Starter

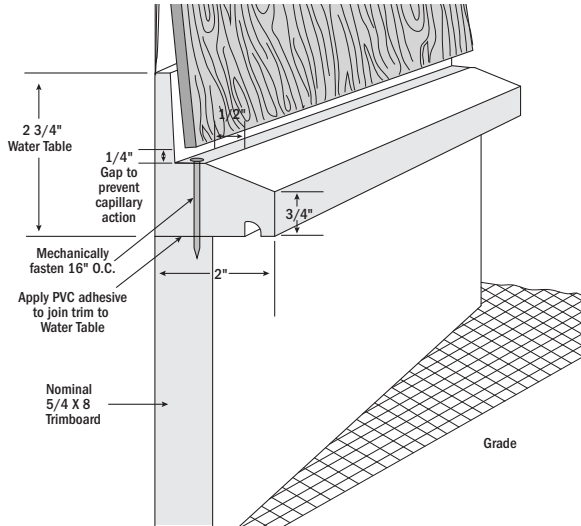

## Starter Board with Drip Cap

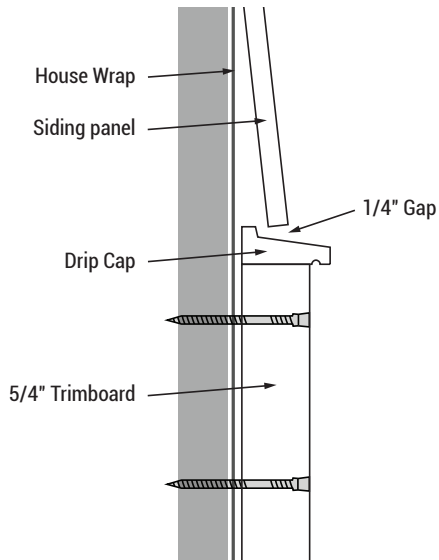

56

## Band Board Installation

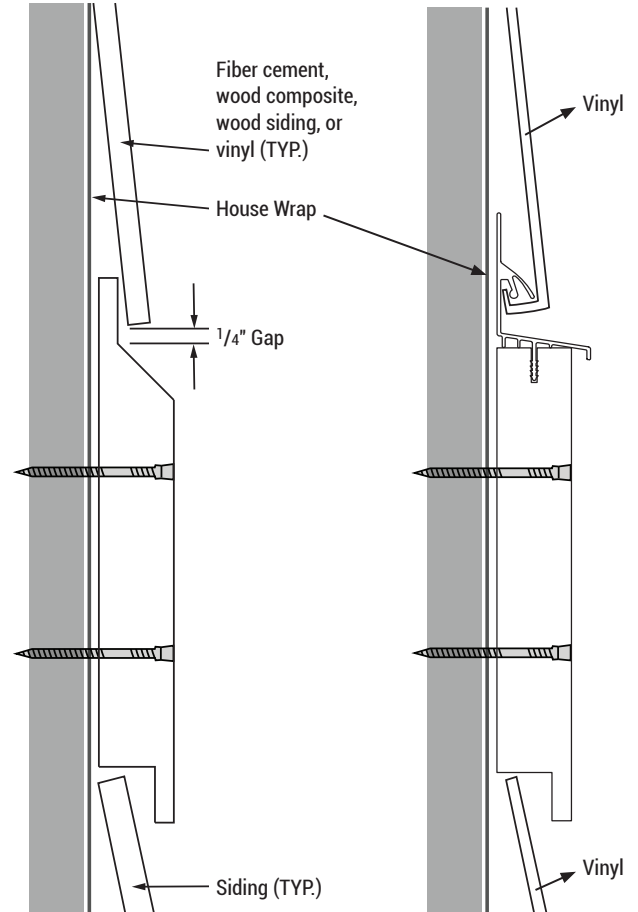

**CONCEPT ONLY.** Use a 5/4 X 8 or 5/4 X 10 VERSATEX Skirtboard to create profile by routing 3/4" Stealth pocket in bottom as shown.

**ABOVE:** Rigid PVC starter strip attached to 5/4 X 8 VERSATEX boards available by special order for bandboard or skirtboard applications using vinyl siding.

57

## VERSATEX Traditional Window Casing

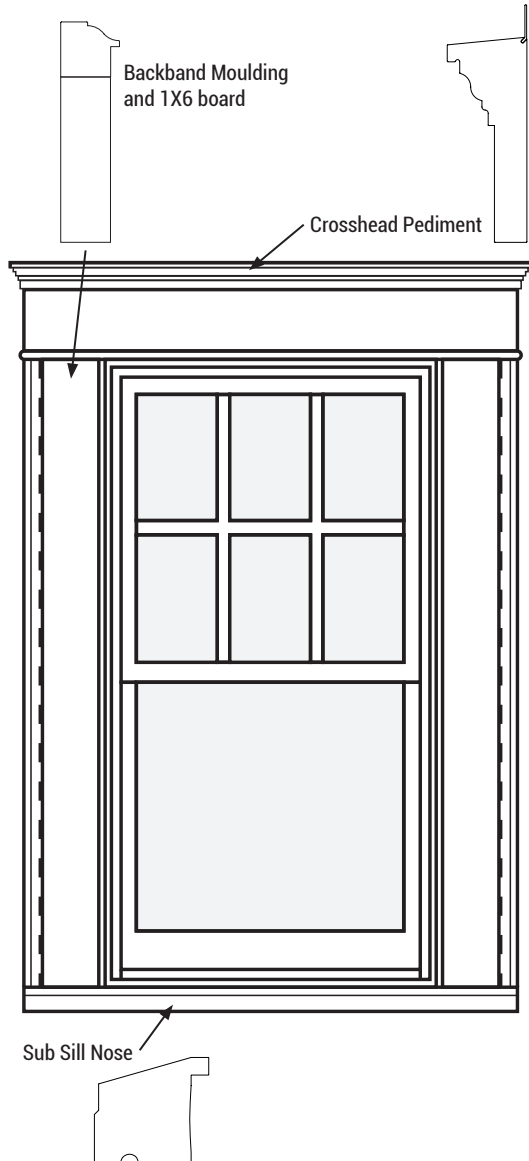

## VERSATEX Inside Hidden Fastener Corner Installation

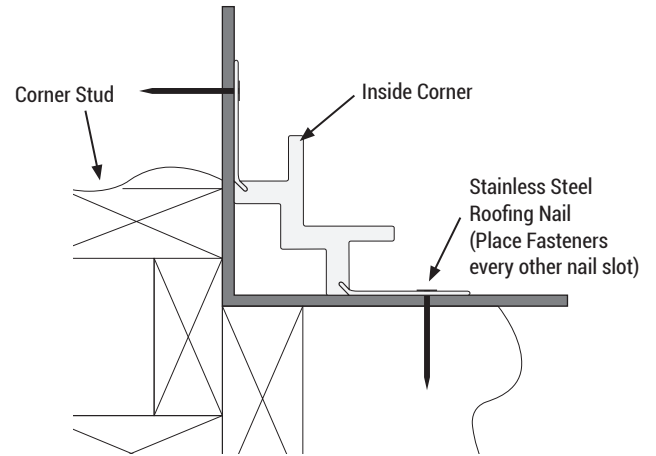

## Alternate Methods: Inside Corner Installation Using 1 1/2" VERSATEX Baluster or VERSATEX Trim

- Apply flash or housewrap in accordance with local building codes.
- Install Baluster or 1", 1 1/4", or 1 1/2" VERSATEX trim piece nailing 16" on center.
- Leave an 1/8" gap between corner and eve.
- Extend Baluster a minimum of 1 1/4" below sheathing.
- Install siding per manufacturer's instructions.

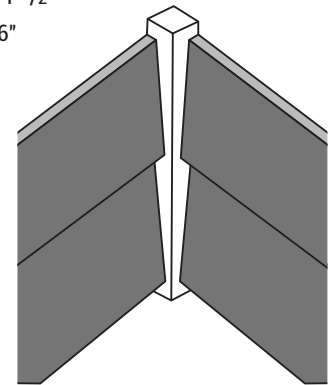

## Inside Corner Installation Using Stealth Trimboard

- Rip a strip 1" wide from a piece of 5/4 Stealth Trimboard.
- Glue and pin nail this piece to another piece of Stealth Trimboard.
- Fasten inside Stealth Corner to wall.
- Insert siding into trim pockets in accordance with manufacturers recommendations.

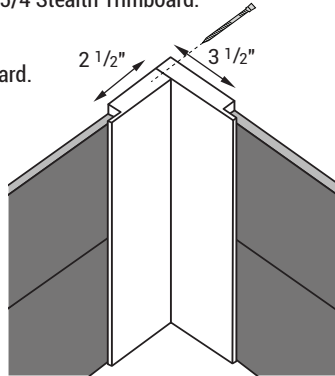

## VERSATEX Garage Door Seal Installation

- Install the header piece first, then the jambs.
- Position the seal so the weather strip is in contact with the garage door. the inside of the seal's base will be approximately 1/2" from the garage door.
- Fasten the base in place with white head, stainless steel trim nails. 6" on center at the head and 6" to 8" on center at the jambs. Pre-drill door seal especially when temperature is below 35°F to prevent cracking of moulding.

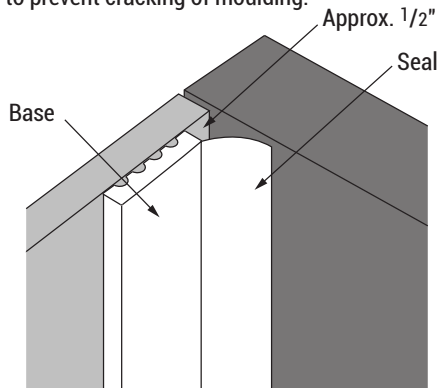

60

## VERSATEX SOFFIT SYSTEM



Frieze Board

Notched Fascia

Vented Soffit

## General Soffit System Installation

- Miter rather than butt soffit at corners. Use a T-Mould at joints rather than sealants or adhesives.
- Fully engage soffit panel into plowed slot on fascia and frieze boards.
- Screen vents with corrosive-resistant mesh if required by code or if there is a concern with insect infiltration. Use staples or adhesive to bond mesh/screen to soffit.

61

- Before installing make sure rafter tail ends are aligned and in the same plane.
- Do not build soffit system on ground. The soffit overhang may not be a perfect 90° angle. Install the three components individually to properly conform to the building structure.
- VERSATEX's Notched Fascia extends 1/2" below the soffit, forming a natural drip edge.
- At all Notched Fascia and Frieze/Rake board joints, use a shiplap joint. A shiplap is not only stronger, but also hides unsightly gaps in the trim.

### Eave Application

**Step 1:** Fit VERSATEX Soffit panel to the overhang, make sure the outside edge of the soffit projects 7/16" beyond the subfascia. Position slotted vents toward the outside of the eave for optimal air flow.

**Step 2:** Secure soffit to the underside of the subfascia and framing member along the other edge of the soffit panel at the frieze. Use 4d or 5d stainless steel nails or trim screws spaced 12" on center at all panel edges and at all intermediate supports. Reduce spacing to 6" on center if soffit is not supported by fascia and frieze.

### Fastening Schedule

Board Width	Fasteners per width a maximum of every 16" on center
12"	3-4
16"	4-5

**Step 3:** Use a T-Mould at the butt joints between two soffit panels and at all mitered soffit corners.

**Step 4:** Use a Standard Stealth Trimboard for the Frieze board, making sure the long flat edge of the trim butts tight against the

soffit panel with the siding pocket on the Stealth Trim at the bottom and against the exterior wall to accept siding.

**Step 5:** Fasten the Frieze board to the wall studs with 8d stainless steel nails with annular threads and blunt points or trim screws spaced a maximum of 16" on center.

**Step 6:** Install the VERSATEX Notched Fascia board on top of the subfascia aligning the pocket with the projecting edge of the VERSATEX Vented Soffit panel before fastening it to the face of the subfascia. To reduce linear movement in the fascia board, glue it to the subfascia with a construction adhesive like Liquid Nails Sub-Floor or Heavy Duty Construction Adhesive.

**Step 7:** The top edge of the fascia can be flashed with a piece of undersill trim or hidden behind a drip edge or other roof edge flashing. Be sure the edge angle on the soffit panel is cut to the same slope as the roof where two soffit panels abut.

### Tips when Installing VERSATEX Soffit System

- If using beadboard for soffit, use 3/4" actual or thicker boards. Never span VERSATEX more than 24".
- If using 1/2" beadboard for soffit, orient it perpendicular to the joists, and fasten every 12" on center. Add nailer for spans greater than 16".

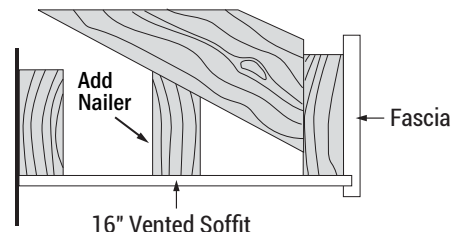



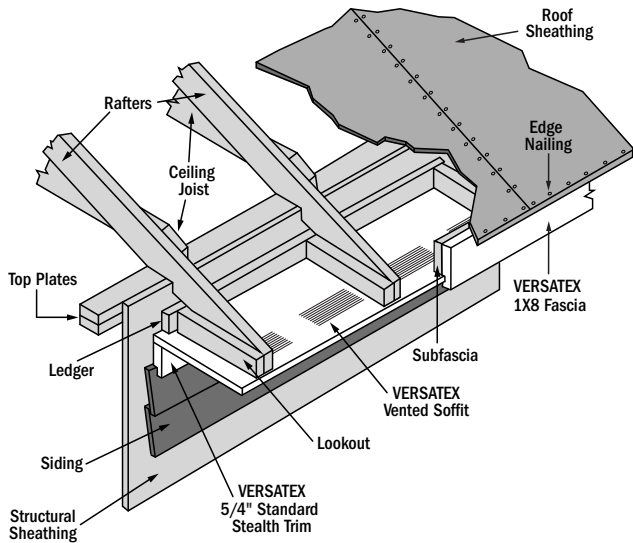

## Beadboard Soffit Detail

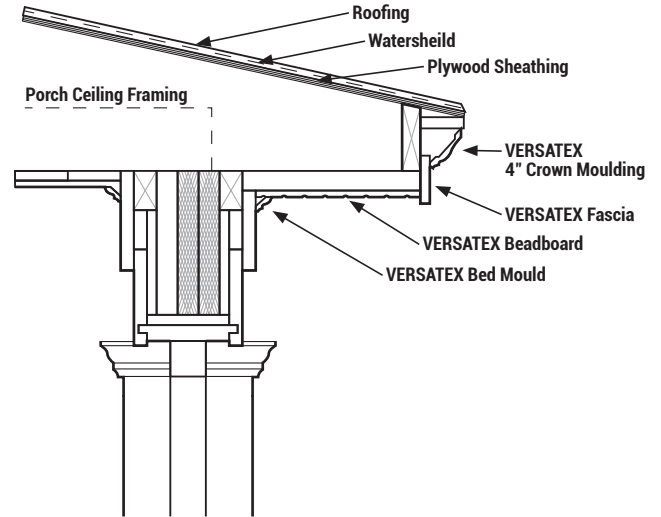

## Soffit System Detail

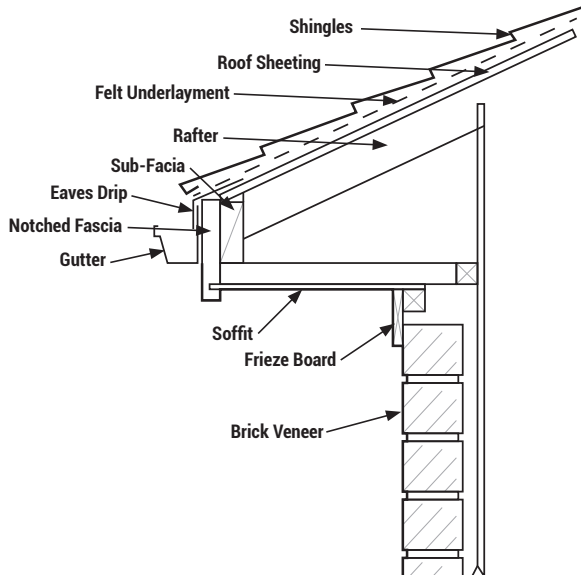

## Vented Soffit and Crown Moulding

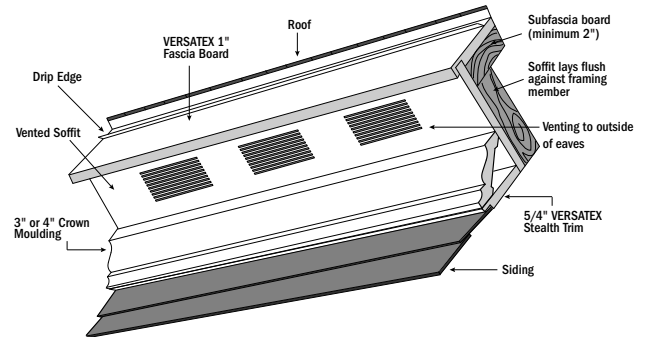

Note: Secure crown or other mouldings with 15ga. stainless steel trim nails.

## PORCH CEILING WITH BEADBOARD (Sheets or Boards)

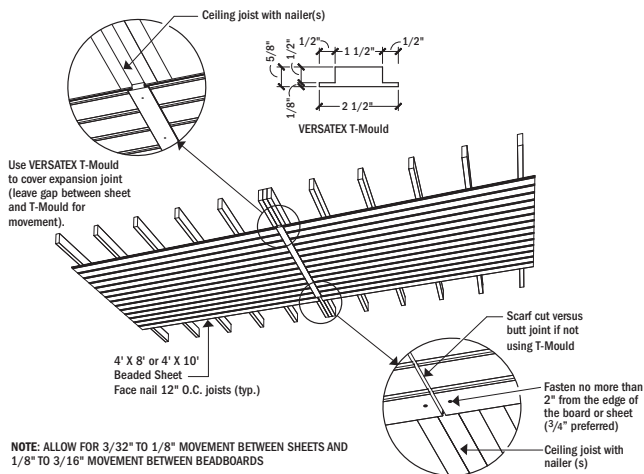

### Support Spacing

VERSATEX must not be used in load bearing applications, but it may be used in spanned applications such as soffits and ceilings.

### Ceiling Installation Tips

VERSATEX Sheet and Beadboard  $\frac{1}{2}$ " or thinner are not designed to be ripped and used for trim applications. These products must be glued and mechanically fastened to the substrate.

- Use  $\frac{3}{4}$ " actual or thicker boards for spans of 16" to 24".
- When using VERSATEX  $\frac{1}{2}$ " Beadboard or  $\frac{1}{2}$ " thick VERSATEX sheet, orient it perpendicular to the joists, fasten every 12" or less on center and apply construction adhesive to the underside of the rafters.
- Never span VERSATEX more than 24".

- Before installing VERSATEX Beadboard, be sure the underside of the ceiling joists are true and level. You may want to place a  $\frac{1}{2}$ " or  $\frac{7}{16}$ " sheet of OSB or plywood to the underside of the ceiling joists to reduce or eliminate joist read-through.

### Beadboard Ceiling Installation

**Step 1:** Cut the beadboard to length by measuring the depth of the porch front to back at the end where you will start installing the beadboard. Subtract  $\frac{1}{2}$ " from this measurement to account for the  $\frac{1}{4}$ " gap you want to leave around the perimeter of the ceiling to allow the beadboard to expand.

**Step 2:** Trim the first board before installing the first piece, calculate how many boards it will take to cover the ceiling. Divide the width of the porch ceiling by the width of the beadboard to get the number of whole boards needed to cover the ceiling. If the last board is less than 2", trim down the first and last board to make the ceiling look evenly spaced.

**Step 3:** Trim the first board to width, cutting off the groove side of the beadboard, leaving the tongue-edge for nailing.

**Step 4:** Face nail the first board, positioning it on the ceiling, groove side  $\frac{1}{4}$ " away from the wall. Using a pneumatic gun and 2" finish nails, face nail the beadboard to the plywood underlayment or ceiling joists every 12" on center. Position the nails  $\frac{1}{2}$ " to  $\frac{3}{4}$ " from the outer edge of the beadboard. Beaded sheet should be nailed 16" on center across the width and 12" on center around the perimeter.

**Step 5:** All beadboards, including the first one, should be nailed every 12" on center through the tongue or extended leg. If you're using Stealth Beadboard, position the pneumatic gun at the back edge of the board's tongue, angle it away from the tongue and to one side. This will keep the nail from pulling out and blocking the tongue when you fit the groove of the next board over it. Slide the

groove of the next board into the tongue of the previous board. If necessary, tap it tightly in place with a hammer and woodblock.

**Tip:** 1/2" Stealth Beadboard should be fastened with 1/4" wide X 1" deep galvanized or stainless steel staples.

**Tip:** Use a scrap of beadboard as your woodblock so you can fit the groove over the tongue and keep it from mushrooming when you hammer.

**Step 6:** Finish installing beadboard over the ceiling. Trim the final board, if necessary, from the tongue side. Install one or more mouldings around the perimeter of the ceiling, making sure the mouldings cover the expansion gap.

**Step 7:** For runs longer than 18', cut a bevel or shiplap joint into the end of the beadboard. Leave a 1/8" gap when installing beadboard at temperatures below 40°F. Consider a "T" moulding or faux beam as a means of hiding the butt ends of the beadboard.

**Step 8:** Where possible, orient the beadboard in the direction that uses the shortest possible board length. As with any ceiling application, be sure any space above the ceiling is properly ventilated to prevent heat build up.

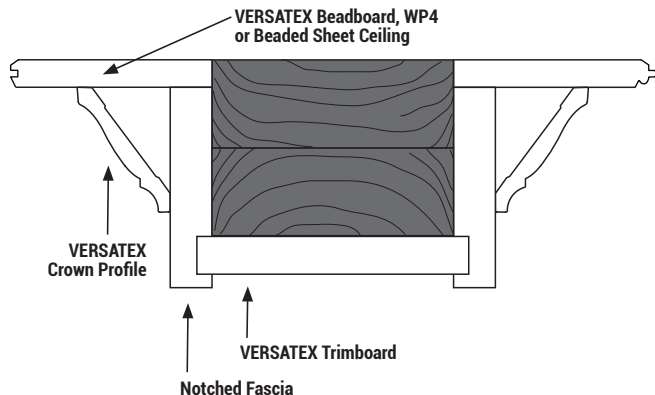

## Wainscoting Detail for Bathrooms, Laundry Rooms, Mud Rooms, and Basements

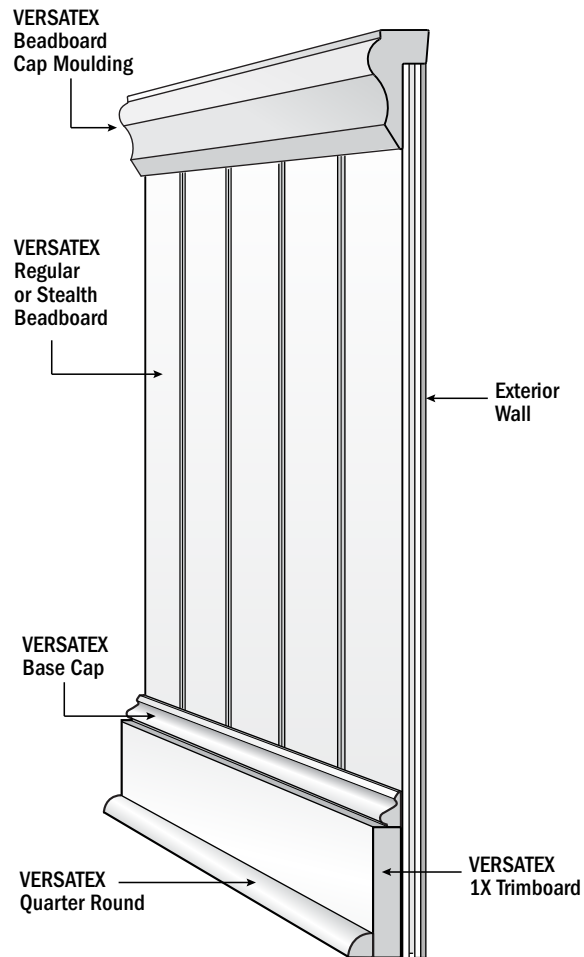

\* Refer to page 9-10 to see additional T&G profile options.

## CANVAS SERIES INSTALLATION GUIDELINES

**\*NOTE: SOLVENT-BASED ADHESIVES AND ACETONE CAN DAMAGE THE APPEARANCE OF CANVAS SERIES PRODUCTS! DO NOT USE FOR INSTALLATION.**

- All Canvas Series products are to be handled like you would a stained piece of mahogany, walnut or any other premium wood and not like dimensional lumber. Keep the product on a skid and covered until time of installation. The faux stained pieces should never be stored on the ground, on asphalt or on any rough surface face down. Boards should be removed from skids by lifting at both ends when possible—friction between laminate and bare board may cause minor marking. See cleaning tips for removal method.
- Install WP4 and Stealth Bead ceiling boards perpendicular to the ceiling joists.
- Check ceiling for square. If the diagonal measurements in each corner are not the same, create a square straight line as a starting point.
- Measure the depth of the porch front to back at the end where you will start installing. Subtract  $1/2$ " from this measurement to account for the  $1/4$ " gap you want to leave around the perimeter of the ceiling to allow for any expansion and contraction. A moulding will eventually cover this small gap.
- Calculate how many boards it will take to cover the ceiling. Divide the width of the porch ceiling by the finished width of the Canvas board to get the number of whole boards needed to cover the ceiling. If the last board is less than 2", trim down the first and last board to create equally spaced bead or "V" groove.

### Finishing for WP4

- Face nail the first board positioning it on the ceiling, cut or groove side  $1/4$ " away from the wall/beam, fascia. Using a pneumatic gun and 2" stainless steel finish nails, face nail the

perimeter WP4 boards to the ceiling joists every 16" on center. Position the nails  $1/2$ " to  $3/4$ " from the outer edge of the WP4.

- All WP4 boards, including the first one, should be nailed every 16" on center through the tongue. Position the pneumatic gun at the back edge of the board's tongue, angle it away from the tongue and to one side. This will keep the nail from pulling out and blocking the tongue when you fit the groove of the next board over it. Slide the groove of the next board into the tongue of the previous board. If necessary, tap it tightly in place with a hammer and wood/strike block.
- Gluing the boards in addition to blind nailing will help anchor the boards securely to a sub-ceiling.
- Use a pencil to trace any cutouts for air vents, electrical boxes or fans on the WP4 boards.
- For runs longer than 18', cut a bevel or shiplap joint into the end of the WP4. Leave a  $1/8$ " gap when installing WP4 at temperatures below 40°F. Consider a T-Mould, faux beam, or coffered ceiling as a means of hiding the butt ends of the WP4.
- Finish installing WP4 over the ceiling. If necessary, trim the final board from the tongue side.

### Ceiling Installation Tips

- Install 4" Crown moulding around the perimeter of the ceiling to conceal the board edges, making sure the moulding covers the  $1/4$ " perimeter gap.
- Use matching touch-up pen and matching wax stick nail hole filler for cut board edges and to cover over exposed fastener holes.

*See page 42 for instructions on cleaning Canvas Series.*

## VERSAWRAP™ CLASSIC & RAISED PANEL INSTALLATION

**Step 1:** Ensure the structural post is sound, straight, and true. If necessary, install thin furring strips or shims (insulation board) to the structural column approximately 4" down from the top center and approximately 4" up from the bottom so that the wrap fits tightly around the structural column/post. Shim all four sides evenly to maintain an equal spacing around the column/post. Be sure the furred/shimmed strips outside dimensions are no wider than the inside dimension of the VERSAWRAP column wrap. (Possible shim material: Homasote board, rigid insulation, or MDF) **TIP:** Use a low expansion urethane foam to fill the cavity between the structural post and VERSAWRAP.

**Step 2:** Apply an adhesive that offers enough cure/working time so it can be applied in the four joints and wrapped around the structural column/post before curing. PVC glues with solvent work well, provided you apply them quickly. PVC adhesives such as Weld-On 705, Christy's Red Hot or Trim Tight are a few recommended solvent-based PVC adhesives. Remember to apply the adhesive to only one surface of the miter lock joints.

**NOTE:** Four VERSAWRAPs can be glued using one 5-oz tube of Weld-On 705 regardless of column length. **TIP:** Do not use 2-component adhesives, urethane adhesives or any viscous adhesives. They are too thick and will fracture your corner joints.

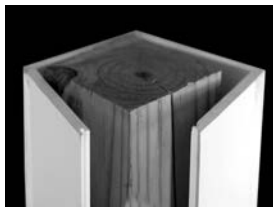

**Step 3:** Once the glue is placed in the VERSAWRAP joints, immediately place it around the structural column or post, pushing the miter lock joint together. Using hand pressure, make sure the locking tongue is properly inserted into the locking groove before completely closing the joint. Close the VERSAWRAP

joint with a piece of scrap PVC trim and a dead blow hammer. Strike the wrap over the joint, not to the right of it, especially during periods of cold weather. If the lockmiter joint is tight, consider wrapping a piece of 320 grit sand paper around a shim or ruler and run it through the groove to loosen the joint. If necessary, take a sanding block with 320 grit sand paper and lightly sand the outside of the lockmiter joint to smooth out any rough spots.



**Step 4:** Secure the VERSAWRAP column wrap to the structural column using stainless steel nails that penetrate through the furring strips to the structural post. **Remove the tape from the corners no more than 4 hours after installation.**

**Step 5:** To remove the tape, be sure the entire width of tape has been lifted across the top before pulling it down the column. If you try to pull the tape down by starting at only one corner, the tape will split. When the tape is started evenly across its entire width and pulled down the column wrap, it will pull off in one piece.

**NOTE:** Leaving the tape on the column wrap and exposed to the UV rays of the sun for more than 24 hours will make it difficult to remove and may leave adhesive residue on the column wrap.

**Tips:** Mild cleaners, mineral spirits, denatured alcohol or a solvent can be used to remove any residual adhesive resulting from leaving the tape on the column wrap for an extended period of time. If necessary, use a hair dryer to help remove the tape at temperatures below 40°F.



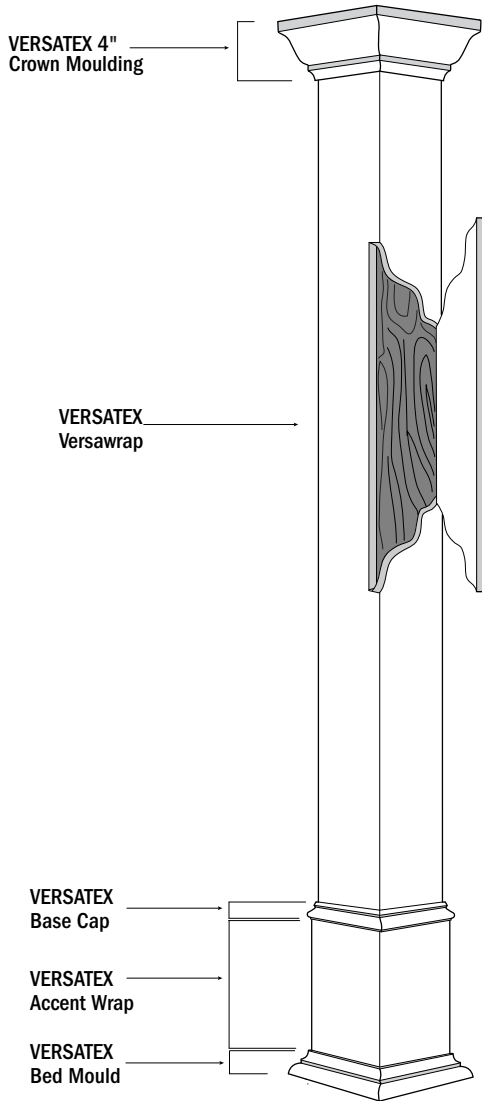

Traditional railing systems easily tie into VERSAWRAP full columns or cut-to-length newel posts. Just wrap your post, add base trim and install bottom support rails & baulsters per manufacturer instructions. Complete the look with VERSAWRAP post caps.

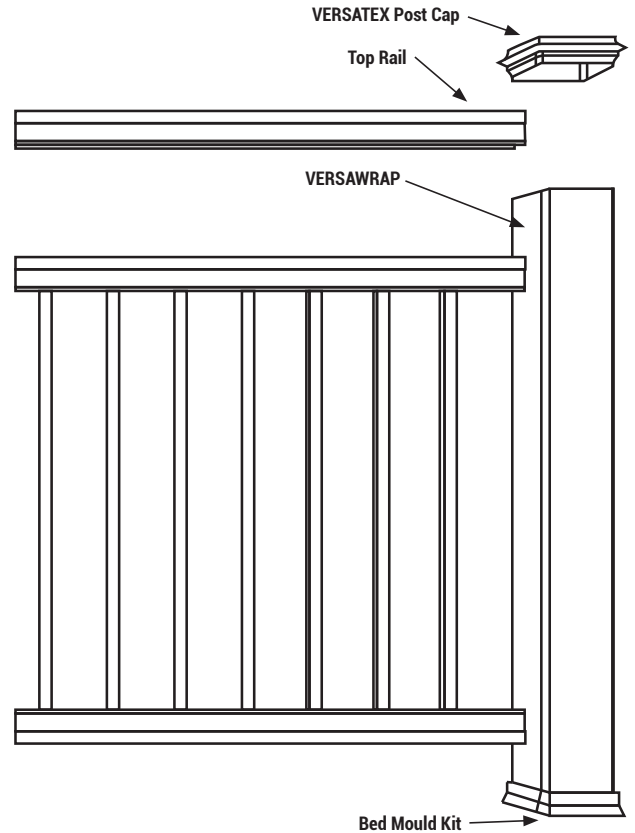

## VERSAWRAP for Railings with Cable Rail

Cable rail systems install similarly. For convenience, you can pre-drill hole locations while your VERSAWRAP is flat, prior to installation around the post.

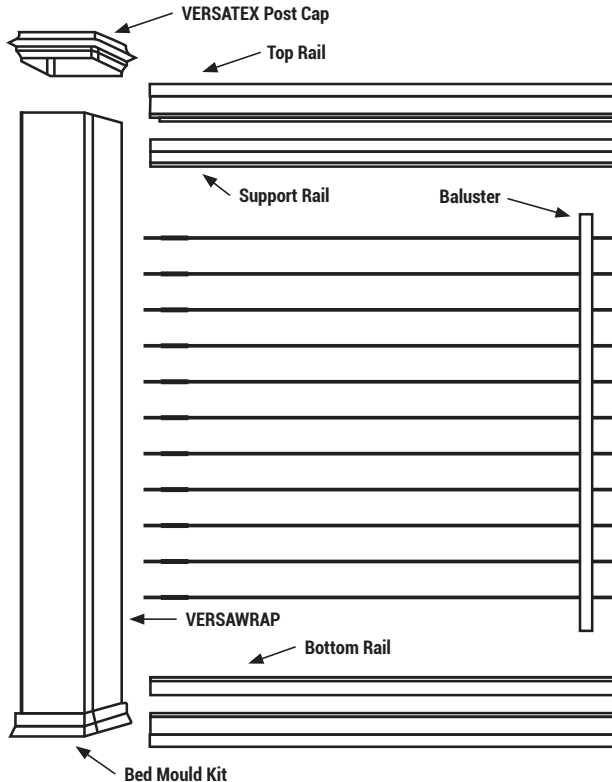

## VERSAWRAP™ TAPERED INSTALLATION

**\*NOTE: Your VERSAWRAP is a decorative column only and is NON-LOAD BEARING! If the column needs to support any weight, a sufficient load-bearing structural post must be in place before installation begins. Care should be taken in handling the individually wrapped VERSAWRAPs to prevent tearing of the tape or cracking at all miter joints.**

Subtract the size of your post from the outside bottom Fastening Angle and divide by two to determine the space between your post and the outside edge of the Fastening Angle.

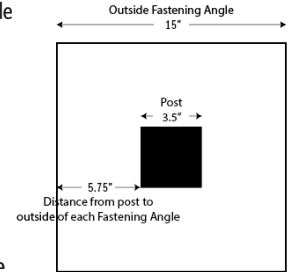

**STEP 1:** Position and screw one small (top) Fastening Angle to the header structure at the top of your structural post, ensuring you measure the distance from the post for centering. We recommend 1½" screws through the pilot holes on each Fastening Angle.

**STEP 2:** If you need to shorten your tapered column, measure and cut each of the four Panels **REMOVING MATERIAL FROM THE BOTTOM ONLY** and resize the two large (bottom) Fastening Angles to fit the new Panel width.

**STEP 3:** Position and screw one bottom (large) Fastening Angle to your floor/pedestal structure on the same sides as the previously secured top (small) Fastening Angle.

**STEP 4:** On a clean work surface, place one Panel with female locking joints facing up and apply PVC adhesive in the grooves on either side. Align each of the male locking joint Panels into the grooves and, using a rubber mallet against the Panel side (**not directly on the open joint**), ensure the Panels fully engage. (see picture)



**STEP 5:** Take this three-sided wrap and place it around your column, fitting it tightly against the Fastening Angles previously installed.

**STEP 6:** Apply glue to the remaining Panel and complete the wrap, again tapping gently with a mallet to fully engage the joints.

**STEP 7:** Align the remaining Fastening Angles tight to prevent movement of the wrap and screw them into place through the pilot holes.

## OPTIONAL ACCENT WRAP

The key to installing the Accent Wrap at the top and bottom of your column wrap is alignment with the panels.

\* Remember that if you modified the height of your column, the length of the large Accent Wrap pieces will also need to be shortened to match the new bottom width.

■ **A:** Align and tape the outside surfaces of two matching Accent Wrap Pieces, ensuring the angled edges are touching under the tape. **B:** Apply PVC adhesive to the inside flat surface of one Accent Wrap Piece (not the angled joint).



■ Fold the two Pieces together and align with the panel while holding the skirt joint at a 90° angle. Apply pressure and pin nail the piece you applied glue to into place. We recommend two pin nails approximately 3" from each end.



■ Peel back the tape from only the unfastened Piece, leaving it attached to the fastened Accent Wrap Piece. Hinge the unfastened Piece away from the column at the taped joint and apply PVC adhesive to **ONE SIDE** of the joint and the inside surface before pressing it in place against the column and pin nailing. Replace the tape over the corner to hold the joint tight while the glue continues to dry.

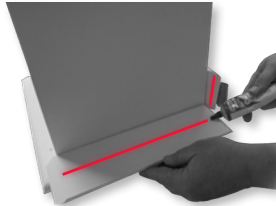

■ Align the third Accent Wrap Piece, adding tape to the edge that will meet the installed Piece, and repeat the gluing and nailing process. Repeat again for the last Piece. The same process can be followed at both the top and bottom of your column.

\* Wait approximately 10-15 minutes before removing the masking tape from the Accent Wrap Pieces to ensure the adhesive has cured. We recommend that your completed column be painted due to open cells left by the milling process on the Fastening Angles and Accent Wrap Pieces. Alternately, these individual pieces can be painted prior to installation.



## Pergola Beam Fabrication (10' - 16' length)

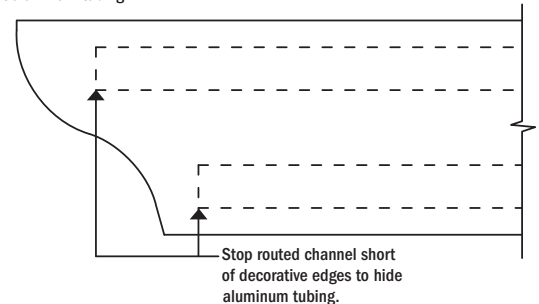
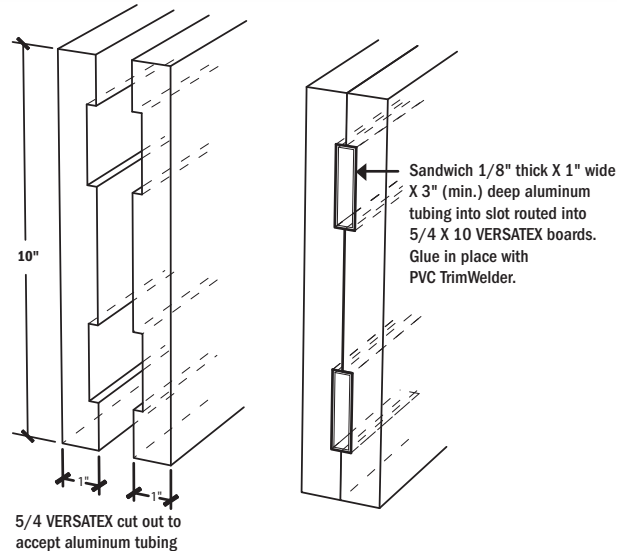

NO REINFORCING REQUIRED FOR BEAM LESS THAN 8' IN LENGTH.





## MOULDING INSTALLATION GUIDELINES

- Use corrosion-resistant, smooth shank, screw, annular threaded or spiral type nails, at least 6d in size and long enough to penetrate at least 1 1/4" into the substrate. Stainless steel fasteners are preferred over galvanized steel.
- If using a nail gun, adjust the length of the stroke, not the air pressure to control nail depth.
- If the temperature of the moulding is below 40°F, pre-drilling is recommended to avoid cracking.
- If screws are preferred, use drywall or deck screws with a large thread or flute, long enough to penetrate substrate by at least 1".
- Slightly countersink screws and finish holes using an exterior spackling or sealant.
- Nails should be placed 12" on center and 3/4" from each edge.
- All bonded surfaces must be smooth, clean, and in complete contact with each other.
- Use exterior-grade, PVC compatible, urethane-based adhesives for bonding VERSATEX mouldings to various substrates. Use solvent-based PVC cement to bond the mouldings to each other.
- Recommended sealants/adhesives include Solar Seal 900 from NPC, Liquid Nails Sub Floor and Heavy Duty Construction Adhesives, and polyurethane sealant/adhesives.
- Use adhesive sealants in addition to mechanical fastening to secure the mouldings to the building frame whenever possible.

**TIP:** Raptor nails could be used as another alternative to stainless nails for moulding installation.

## Brick Mould Installation Guidelines

- Measure top Brick Mould to overlap the jamb material by 1/2". This will allow for a 1/8" to 1/4" reveal around the jamb. Cut a 45° angle on the Brick Mould ends, butt or angle joint middle seam if needed. **Note:** Reveal may vary depending on siding, siding J-channel, brick or block installation. Be sure the moulding pieces are fairly tight and with minimum gaps. Properly seal the moulding pieces to the brick.
- When nailing, use 8d nails or 3" galvanized finishing nails, and space nails 8" to 10" apart. Counter sink nails 1/16" below the surface of the Brick Mould. Nails should penetrate the structural frame at least 1". To conceal nail holes, use a sealant or epoxy. Sealants such as Quad by OSI or NPC Solar Seal 900 sealants work well with cellular PVC products. If you prefer a harder, more durable surface, PVC TrimWelder is recommended.
- Nails can be placed as close as 3/8" to the edge of the Brick Mould. For optimum fit, use Weld-On 705 white PVC adhesive or equal to bond the mitered corners of the brick mould. If you prefer to bond the brick mould to a wood substrate, we recommend Liquid Nails Sub Floor or Heavy Duty Construction adhesives.
- Seal around the brick mould where it meets the siding material. When installing a storm door or combination door, be sure the brick mould is firmly attached before installing the combination door.

## Drip Cap, Rake, and Sub Sill Moulding Application

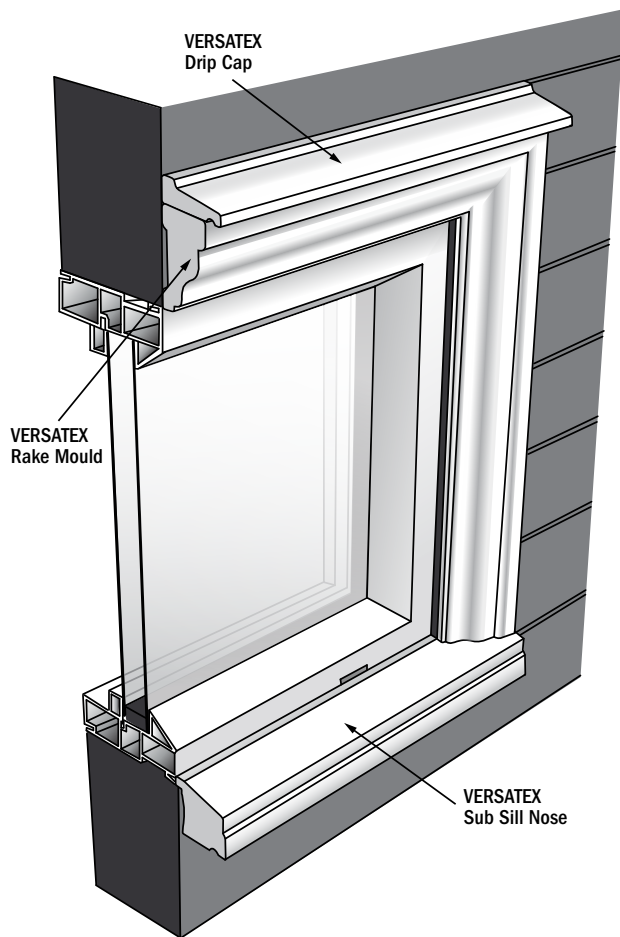

## Sill and Brick Mould Window Application

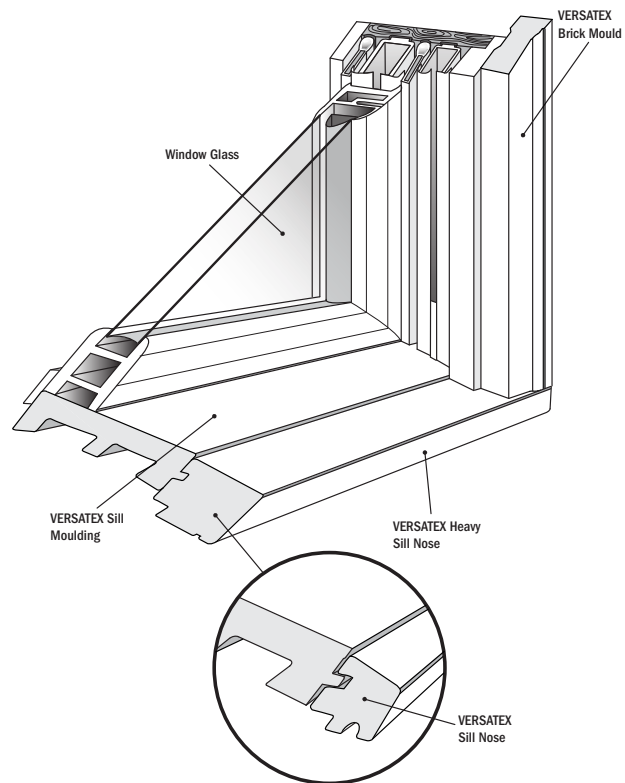



### III. FREQUENTLY ASKED QUESTIONS

#### **Does VERSATEX exterior trim require special code approval?**

No. However, VERSATEX is approved under its Code Compliance Research Report #CCRR-0149 from Architectural Testing. The report is applicable to all lengths and widths of VERSATEX trimboards, sheets, cornerboards, soffit, fascia, frieze, column wraps, Stealth Trim profiles, beaded products and moulding profiles. VERSATEX 1/2 X 6 regular and Stealth Beadboard has passed the stringent UL580 Wind Test for coastal ceiling applications.

#### **Does VERSATEX trim require painting?**

VERSATEX does not require painting to validate the warranty.

#### **Does VERSATEX require a primer?**

A primer may be needed to receive the paint manufacturer's warranty. Excellent adhesion can be achieved by properly cleaning the board with a detergent or denatured alcohol before applying a top coat of paint to VERSATEX.

#### **What type of paint do you recommend for coating VERSATEX trim?**

100% acrylic latex or 100% acrylic latex with a urethane additive should be used to achieve superior coating adhesion and flexibility. Lacquers are not recommended with VERSATEX because lacquers are a more brittle coating and will not flex with movement in the VERSATEX trim. Sherwin Williams, PPG, and Benjamin Moore produce a variety of latex paints specifically for cellular PVC trim. Paint on VERSATEX will last four to five times longer than paints on wood or wood composites due to the absence of moisture in the substrate. If painting dark colors, Aquasurtech light reflective coatings are approved.

#### **What preparation steps should be followed before painting VERSATEX trim?**

Follow the paint manufacturer's preparation steps. To ensure good adhesion, the surface of the product should be clean, dry and free of dirt, mildew, chalk, grease and any other surface contaminants before applying paint. Keep in mind that cellular PVC may have a static charge on the surface of the product which tends to attract dust. Cleaning can be accomplished using a mixture of a mild detergent (Spic 'n Span®) and water. Other cleaning agents include mild household cleaners, or degreasers for more stubborn stains. Prior to cleaning, it is a good practice to fill all nail holes and remove any marks or blemishes that appear during the installation process. Sanding the surface is an acceptable method of removing blemishes if painting. However, sanding the original exterior surface will expose the micro cell structure.

#### **Can I paint over a dark color with a heat reflective coating?**

No. The dark color must be stripped off before applying a heat reflective paint.

#### **Do I need to scuff the product before I paint?**

No. The gloss on VERSATEX is low enough that no mechanical form of surface preparation is required to assure good paint adhesion. Wiping the boards with denatured alcohol, however, will improve paint adhesion.

#### **How do I fasten or join VERSATEX PVC trim?**

As with wood, VERSATEX can be fastened or joined to itself or other substrates using nails, screws, PVC glues, quality polyurethane adhesives, 2-component adhesives (MMAs), and cyanoacrylates or super glues. A shiplap joint works best. Butt joints are not recommended. For more information on fastening, joining or gluing VERSATEX, please refer to Section C of the Technical Help page on [versatex.com](http://versatex.com).

### **What is the best fastening system for VERSATEX PVC trim that also hides the fastener heads?**

The best systems for securing VERSATEX trim are the Cortex Concealed Fastening System or Starborn Pro Plug System. Both combine the advantages of using a screw (strong connection) with the VERSATEX tapered plug that fits into the hole created by the screw, eliminating the need for fillers or sealants to fill the nail holes. Plugs are available in Smooth and Timber Ridge.

### **Does VERSATEX require pre-drilling before fastening?**

Pre-drilling typically is not required unless large diameter fasteners are used (not recommended) or the product is installed or has been outside when temperatures are below 40°F.

### **Do you recommend nails or screws for fastening VERSATEX trim?**

We recommend stainless steel screws over nails. Screws help to limit thermal movement of the trim. However, if you do use nails, use a 7d or 8d, 12/13 gauge, 316 stainless steel nail with annular threads or a combination of annular threads and ring shank. Simpson Strong-Tie makes a PVC Trim-Board Nail.

### **What if I want to use a nail rather than a screw? What are my options for filling the nail holes?**

DAP Platinum Patch Advanced Exterior Filler high performance paste or another high-performance, weatherable vinyl spackling paste.

### **Do you recommend gluing a PVC trim fascia board to the wooden subfascia?**

We do. It is just one more step in controlling thermal movement in the VERSATEX trim. Products for gluing VERSATEX to wood include Liquid Nails Heavy Duty Construction Adhesive, Liquid Nails Sub-Floor Adhesive, and even NPC Solar Seal #900.

### **Do you recommend all joints be glued or should we leave a caulked joint(s) to allow for product movement?**

We recommend the highly visible joints be glued and other less visible joints act as expansion joints. A common method used by contractors is shiplapping the edges of the boards on long runs. This allows for product movement while never exposing the substrate or house wrap. It also increases the surface area of the joint should you decide to glue it.

### **What is the best glue for joining two pieces of VERSATEX trim? What is the best glue for bonding PVC trim to wood? To metal?**

We recommend a PVC pipe glue with solvent for bonding the ends of VERSATEX boards to themselves (Weld-On 705 or Christy's Red Hot White Vinyl Adhesive) or better yet Extreme Adhesives PVC TrimWelder whenever you are bonding boards, a shiplap or miter cut (window surround) or even sheets of VERSATEX. For bonding to wood, we recommend Liquid Nails Sub-Floor Adhesive or Heavy Duty Construction Adhesive. For VERSATEX to metal, we suggest Extreme Adhesives PVC TrimWelder. There are three types of Extreme Adhesives PVC TrimWelder: Slow Cure and Fast Cure, both used for field joints and small glue ups, and Laminating Grade, used for sheet glue-ups. Slow Cure should not be used at temperatures below 40°F.

### **How should VERSATEX trim be secured to masonry?**

We recommend the masonry be troweled with a sealant or adhesive first to provide a level/plumb surface to accept the board/sheet and the trim secured with Buildex Tapcon masonry fasteners. Another option is the Aerosmith fastening system. You can learn more about the system at [www.aerosmithfastening.com](http://www.aerosmithfastening.com).

### **Can I use just glue or do I have to use glue in combination with fasteners?**

You must use a combination of glue and mechanical fasteners. The glue is not enough to ensure a long term bond.

### **How long does it take the paint to cure on PVC trim?**

That depends on the weather conditions. Warm/dry weather will allow the paint to cure faster than cool/humid weather. It can take up to 30 days for paint to fully cure on PVC trim, because PVC trim is impervious to moisture. For the paint to cure, the moisture must evaporate through the surface of the coating that has skimmed over from drying.

### **Does VERSATEX burn?**

Cellular PVC will not support combustion and will only burn when in direct contact with a flame source. It also carries a flame spread rating of less than 25, giving it a Class "A" fire rating when used in an exterior application.

### **VERSATEX trim is more expensive than finger-jointed pine and composite wood trims. Is it worth the price?**

VERSATEX offers a limited lifetime transferrable warranty (please refer to [versatex.com/warranty](http://versatex.com/warranty) for full warranty information). Unlike wood or wood composites which have no warranty and require periodic painting and sealing to protect them from the elements, VERSATEX Trimboards do not require any special installation details or protection from the weather and will last a lifetime. Independent third party studies have shown the life cycle cost of VERSATEX to be less than wood, wood composite and other composite trims.

### **What is the compressive strength of VERSATEX trim?**

When tested in accordance with ASTM D 695, VERSATEX trim (1/4" to 3/4") achieved ultimate compressive strength values between 2000 psi to 6000 psi, depending on the product thickness. The thinner the VERSATEX sheet/board, the higher the compressive strength.

### **Can I rip a 3/8" or 1/2" VERSATEX sheet into boards and use them as a fascia provided I have a solid wood subfascia? What is the recommended method of attaching this thin board to the subfascia?**

Although not recommended, some contractors have ripped 1/2" and 3/8" sheet for use as a fascia trim. However, in all cases there has been a structural subfascia to which the 1/2" or 3/8" fascia board has been "fully glued" and "fastened" (screwed or nailed). These thicknesses should never be used as trim unless they are glued and mechanically fastened to a solid substrate.

### **When using VERSATEX trim as a column wrap over a treated 4 x 4 or 6 x 6, can I fasten the column wrap directly to the treated member?**

You should not attach the VERSATEX column wrap directly to the treated column post. These posts are typically wet from pressure treating and when they dry, they have a tendency to twist. This twisting action can cause the miter or butt joints on the column wrap to open if the column wrap is placed tight against the post. Instead, install furring strips or blocking around the load-bearing post, making sure the outside dimension of the furring strips or blocking is no larger than the inside dimension of the column wrap. Some contractors use a low density spray foam insulation to fill the gap between the posts & wrap. When the post twists the foam insulation is crushed to compensate for the twisting action.

### **Can I use the VERSATEX Stealth Trim System with fiber cement sidings, vinyl sidings, or any composite wood or vinyl sidings without voiding their warranty?**

Yes. Stealth is an accepted trim system with these siding products. Stealth Trim not only improves the overall aesthetic value of the finished product, but also helps you meet certain installation criteria, such as keeping the siding 6" above grade (Stealth Skirtboard) or two inches off a roof line.

### **What are your recommendations for dealing with expansion and contraction?**

Use stainless steel annular shank nails or screws designed for wood trim and long enough to penetrate the solid substrate a minimum of 1 1/4". Screws are better for controlling the thermal movement of the trim. Allow VERSATEX to acclimate to outside temperatures before installing. Bond VERSATEX joints to prevent separation. Be sure to allow adequate expansion and contraction space at the end of long runs. Decrease the on center spacing between fasteners to 12" or less and bond boards to substrate when practical. Shiplap joints are superior to scarf cut joints, especially on long runs.

### **Any suggestions on what to do to exposed edges or exposed cells once VERSATEX has been cut, routed or milled?**

There are a couple of methods used by contractors and OEMs to seal the exposed cells on VERSATEX Trim. One technique is to wipe the exposed area with a solvent. Solvents tend to soften or melt the cells, sealing them from dust and dirt. Another technique is to sand the exposed cells with a very fine 320 grit sand paper and then either wipe them with solvent or paint the area. The fine sanding reduces the cell size, allowing better paint coverage. In some cases, sanding with 320 grit paper and then wiping down the area with solvent eliminates the short term need for painting.

### **What type of fasteners are recommended to secure VERSATEX to the building?**

Use 8d stainless steel fasteners designed for wood trim and siding. Fasteners with thin shanks, blunt points, and full round heads are preferred; annular threaded or spiral type nails are also recommended. If screws are preferred, use a #7 or #8 stainless steel trim screw with a painted white head. We do not recommend galvanized fasteners, since they tend to lose their coatings and rust.

### **What type of nails are recommended?**

Simpson Strong-Tie 316 SS PVC Trim-Board Nails or combination of annular screw threads with ring shanks near the top.

### **Do these nails come collated so I can gun nail them?**

Maybe. Contact VERSATEX or Simpson Strong-Tie for more information on gun types for use with PVC Trim-Board Nails. As for screws, you have choices: #8 gauge TrimTop 305 SS with sharp type 17 piercing point by FastenMaster; 305 SS Headcote #7 or #8 trim screws with auger points; or Simpson Strong-Tie finishing (trim) screw.

### **What is the best way to hide the nail/screw head?**

The absolute best way to hide the fastener head is to use the Cortex Concealed Fastening System by FastenMaster or the Pro Plug System by Starborn. Both systems utilize a countersunk trim screw and a plug made from VERSATEX. If you are painting the VERSATEX trim, Platinum Patch Advanced Exterior Filler by DAP is an excellent high performance spackling paste that is also a very good nail hole filler. If you don't intend to paint the trim, use one of the screw and plug systems mentioned above.

### **What is the recommended fastening spacing for a VERSATEX board used in a long fascia, rake or frieze application?**

16" on center spacing (max), although 12" on center is preferred with 2 fasteners on nominal 4 and 6 wide boards, 3 fasteners on nominal 8 and 10 wide boards, 4 fasteners on a nominal 12 wide board and 5 fasteners on a nominal 16 wide board.

### **What is the recommended fastening spacing for a soffit application?**

12" on center spacing (max) along the perimeter edges of the board, 16" on center across the width at rafter tails.

### **What are the recommended installation temperatures?**

Try to install VERSATEX trimboards between 50°F and 80°F. The ideal temperature for installing long runs of VERSATEX is 55°F to 60°F. This is roughly the midpoint between the high and low temperatures the boards will be exposed to. Keep in mind the board may be colder than the air temperature, especially during the winter months, so if possible, try to warm up the boards before installing them.

### **Can VERSATEX trim be used in interior applications?**

VERSATEX trim products can and has been used on a variety of interior applications. However, check with your local building code official before installing VERSATEX in any interior application.

### **What are the recommended adhesives/sealants I should use with VERSATEX?**

There are many adhesives to choose from, and it depends on the application and the substrates you are trying to bond together. For bonding VERSATEX to itself, use a PVC cement with solvent or a two-component adhesive. Weld-On 705 or Christy's Red Hot White Vinyl Adhesive are acceptable PVC adhesives. If a two-component adhesive is specified, use Extreme Adhesives PVC TrimWelder. It provides a near structural bond to most substrates that is stronger than the product itself. As for sealants, you have Titebond PVC Trim or NPC Solar Seal #900 Sealant/Adhesive in Trimboard white #111. They bond and seal to VERSATEX as well as many other substrates. Other recommended sealants include Quad by OSI, and Geocel 2300, and just about any polyurethane sealant. Do not use silicone sealants since they are not compatible with cellular PVC trim.

### **Can VERSATEX cellular PVC trim be heat bent?**

Yes, VERSATEX can be heat bent using circulating ovens, stripheaters, radiant heaters and wallpaper steamers. Heat bending is as much an art as a science and will require experimentation to determine the optimum set temperature and dwell time to produce the best curved trimboard. **Heat bending embossed trim will cause the wood grain to disappear. Always wear protective gloves. Hot PVC can produce severe burns.**

### **What other methods can be used to produce a radius trimboard?**

Sheet goods can be an alternative and at times a cost effective method for creating shapes.



VERSATEX Trim and VERSATEX Mouldings should be installed using the same good building principles used to install wood trim and mouldings and in accordance with the local building codes and the installation guidelines included in this handbook. VERSATEX Building Products, LLC accepts no liability or responsibility for the improper installation of this product.

VERSATEX Trim and VERSATEX Mouldings may not be suitable for every application and it is the sole responsibility of the installer to be sure that VERSATEX Trim and Mouldings are fit for the intended use. Since all installations are unique, it is also the installer's responsibility to determine specific requirements in regards to each trim and moulding application.

VERSATEX Building Products recommends that all applications be reviewed by a licensed architect, engineer or local building official before installation. If you have any questions or need further assistance, please call VERSATEX Customer Service at 724. 857. 1111 or visit our website at [www.versatex.com](http://www.versatex.com)

## **OTHER CONSTRUCTION DOCUMENTS**

(Available Online)

**CCRR-Report #0149 and UL580 Wind Test  
(third party verification for National Code Listing)**

**Architectural Specifications for Section 06 60 00**

**Complete Digital Architect Binder**

[versatex.com/architect-binder](http://versatex.com/architect-binder)

**Various Technical Bulletins**

Thermoforming

Paints, Sealants, Adhesives

Fastening, Cutting, Moulding and Millwork

Physical Properties

**VERSATEX Green Attributes**

**[versatex.com/green](http://versatex.com/green)**

Many of these and other documents can be obtained by calling us at 724.857.1111 or by accessing them through [versatex.com](http://versatex.com).

**If you have any suggested details you would like to see us add to the Contractor Handbook, please email us your ideas to [sales@versatex.com](mailto:sales@versatex.com).**



**NOTES**

**NOTES**

**NOTES**

**NOTES**

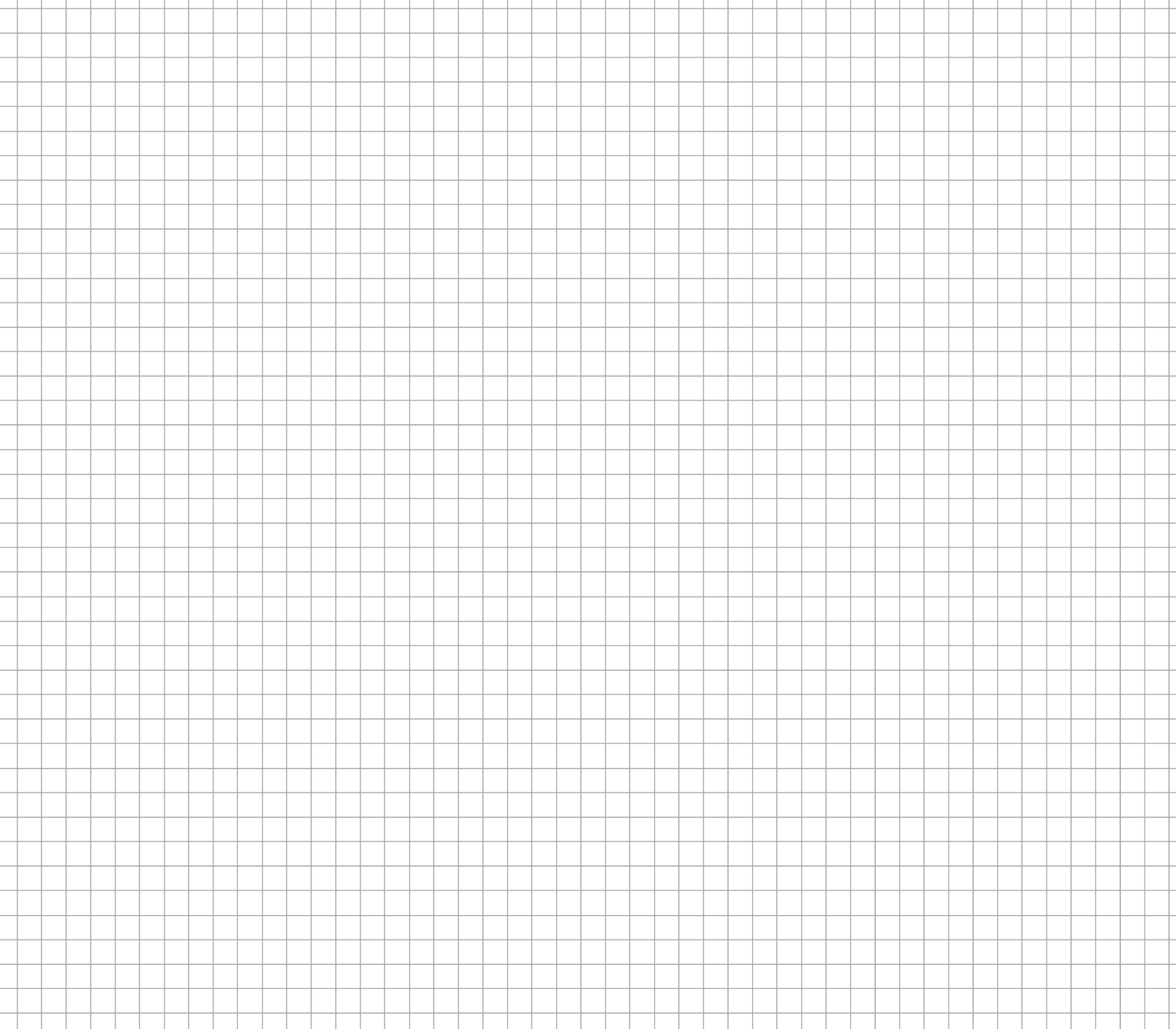

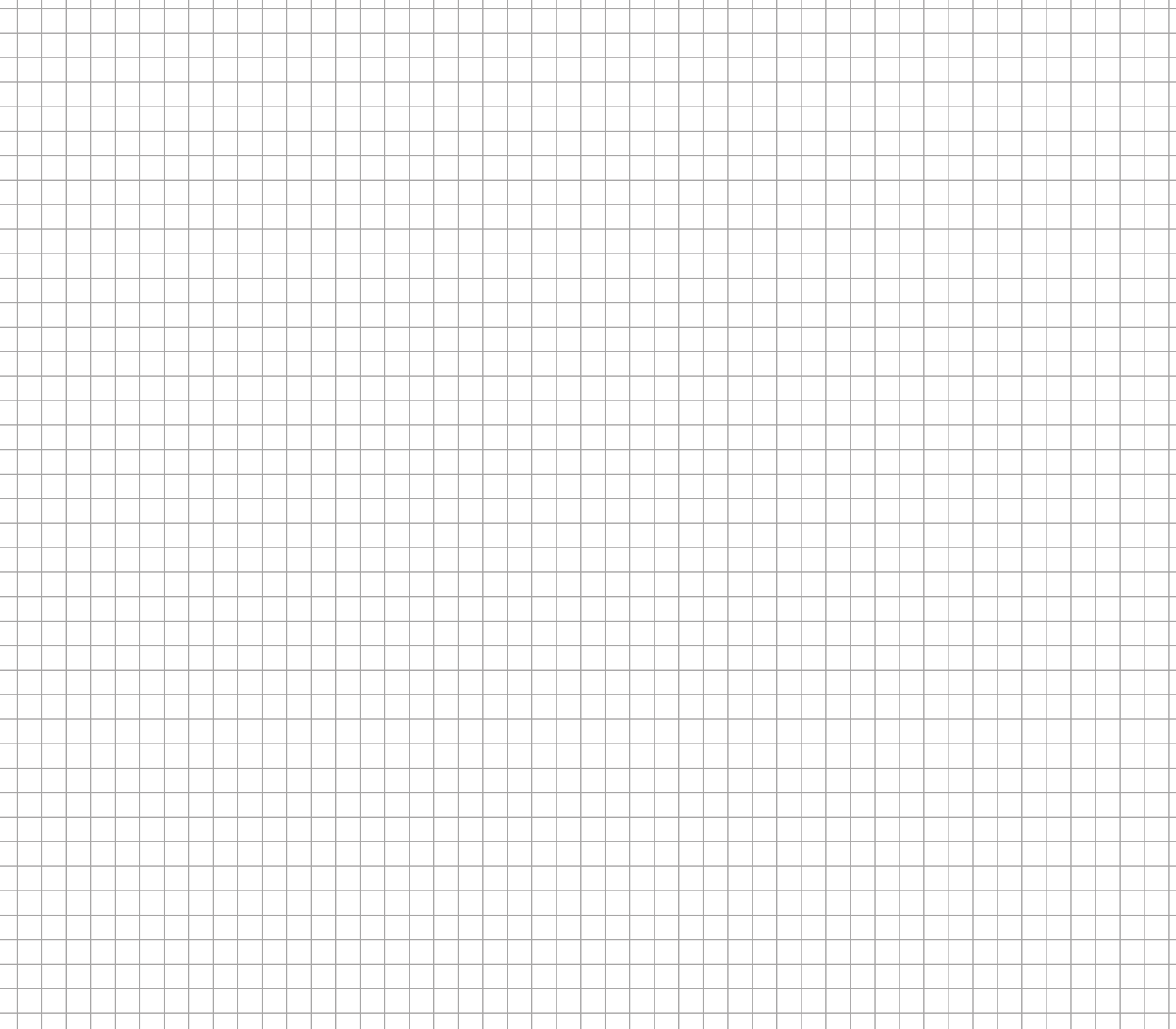



# VERSATEX<sup>®</sup>

## BUILDING PRODUCTS



Download the Premier Builder app & our  
VERSATEX Contractor Handbook app

Available on the App Store and Google Play™



Apple and the Apple logo are trademarks of Apple Inc., registered in the U.S. and other countries. App Store is a service mark of Apple Inc. and Google Play is a trademark of Google Inc.

A Product of VERSATEX Building Products, LLC  
400 Steel Street | Aliquippa, PA 15001 | 724.857.1111 | versatex.com